



MODEL CM

BELT DRIVEN UTILITY VENT SET OVERVIEW

The CM Series belt driven backward inclined Utility Vent Set fans from S&P offer an excellent choice of product for all medium and high pressure exhaust or supply applications for commercial, institutional or light industrial air moving projects. Both models are supplied complete with motor mounted on an adjustable base; v-belt drives; heavy duty ball bearings and integral mounting platform. The installer friendly design simplifies and reduces the cost of installation. Each complete fan is tested prior to shipping to ensure smooth, vibration free and consistently reliable operation to provide years of dependable service with minimal maintenance.

The CM, CME & CMI Series from S&P are available in four distinctly different construction arrangements to meet a wide range of demanding specialist exhaust or supply applications.

CM

Heavy Duty

Suitable for general, grease laden or high temperature (Smoke & Heat) airstream exhaust applications.

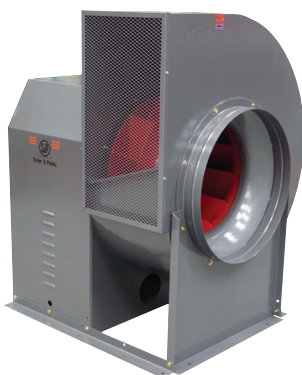

Standard Features

- AMCA Air and Sound Certified (except size 10)
- Performance: 500-25,000 CFM with Static Pressures up to 5.5 in. W.G.
- Backward inclined CW or CCW orientation non-overloading wheels, sizes 10 - 36 ins
- Steel sheet metal construction with corrosion resistant Epoxy Powder Coating, and welded scroll for airtight lock seam
- Adjustable rotation and discharge orientations in accordance with AMCA 99-2406-83 Standards

Models CM

- cULus 705, Power Ventilator
- Operating Temp -20°F to +200°F continuous

Models CM-RHUL

- cULus 762, Power Ventilator for Restaurant Exhaust Applications
- Operating Temp -20°F to +400°F continuous

Models CM-HT

- cULus 793, Power Ventilator for Smoke Control Systems
- Designed and UL Listed to withstand inlet temperatures of 500°F for 4 hours and 1000°F for 45 minutes.

Models CME and CMI are available by special quote only and at longer delivery schedules than regular CM units. Please contact the factory for pricing and size availability.

CME

Heavy Duty

Suitable for potentially explosive or flammable airstream exhaust applications.

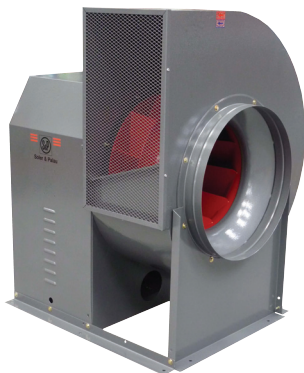

Standard Features:

- AMCA Air & Sound Certified
- Performance: 500-25,000 CFM with Static Pressures up to 5.5 in. W.G.
- Backward inclined CW or CCW orientation non-overloading wheels, sizes 10 - 36 ins.
- Various construction configurations available dependant upon the AMCA 99-0401-86 Standard requirements
- Adjustable rotation and discharge orientations in accordance with AMCA 99-2406-83 Standards

Models CME-C

- cULus705, Power Ventilator
- Operating Temp -20°F to +200°F continuous.
- AMCA TYPE-C Spark Proof Rating
- Corrosion resistant epoxy coated steel wheel and scroll with non-ferrous inlet venturi

Please contact factory for availability and delivery schedules of CME models.

CMI

Heavy Duty

Suitable for corrosive airstream exhaust applications.

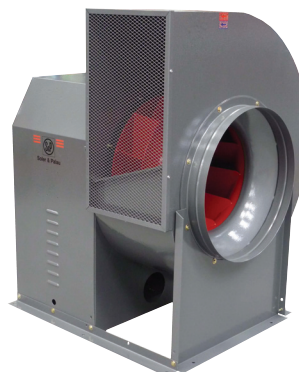

Standard Features:

- AMCA Air & Sound Certified
- Performance: 500-25,000 CFM with Static Pressures up to 5.5 in. W.G.
- Backward inclined CW or CCW orientation non-overloading wheels.
- Stainless Steel construction. Includes, scroll (housing), wheel, inlet venturi and shaft
- Adjustable rotation and discharge orientations in accordance with AMCA 99-2406-83 Standards.

Models CMI

- cULus 705, Power Ventilator
- Unit is designed to operate at temperatures of -20°F to +600°F continuous.

Not available in all sizes, please contact factory for availability and delivery schedules of CMI models.



MODEL CM

BELT DRIVEN UTILITY VENT SET

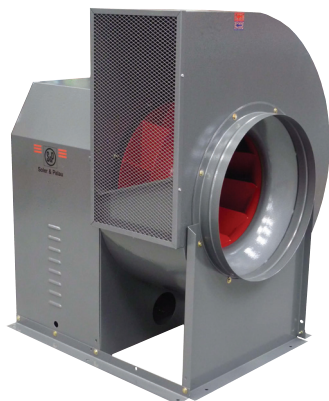

MODEL FEATURES

- Exhaust air to over 21,000 CFM in static pressure capabilities to 5.5"
- Belt drives permit easy performance adjustments when needed
- Backward inclined CW or CCW orientation non-overloading wheels, sizes 10 - 36 ins.
- Steel sheet metal construction with corrosion resistant Epoxy Powder Coating, and welded scroll for airtight lock seam
- Adjustable rotation and discharge orientations in accordance with AMCA 99-2406-83 Standards
- AMCA Air and Sound Licensed
- cULus 705,762, 793 Listed

APPLICATION CONSTRUCTION OPTIONS

MODEL NAME	TYPICAL APPLICATIONS
CM	<ul style="list-style-type: none"> • Suitable for removal of clean or contaminated air in general applications • UL705 listed • Operating Temp -20°F to +200°F continuous
CM-RHUL	<ul style="list-style-type: none"> • Suitable grease laden airstream exhaust applications. • UL762 listed for grease removal • Operating Temp -20°F to +400°F continuous
CM-HT	<ul style="list-style-type: none"> • Suitable for high temperature (Smoke & Heat) airstream exhaust applications. • UL793 listed for smoke control systems • Listed for emergency heat and smoke removal. Designed and UL Listed to withstand inlet temperatures of 500°F for 4 hours and 1000°F for 45 minutes.
CME-C	<ul style="list-style-type: none"> • Suitable for potentially explosive or flammable airstream exhaust applications. • AMCA Type-C Spark Proof Rating • Operating Temp -20°F to +200°F continuous • <i>Contact Factory for availability and delivery schedules.</i>
CMI	<ul style="list-style-type: none"> • Suitable for corrosive airstream exhaust applications. • UL705 listed • Unit is designed to operate at temperatures of -20°F to +600°F continuous. • <i>Contact Factory for size availability and delivery schedules.</i>

MODEL OVERVIEW

S&P's Model CM is available in a full range of sizes (10 through 36) provides airflow performance from 500 CFM to over 24,500 CFM with static pressure up to 5.5 in. w.g. This single inlet backward inclined utility fan provides substantial benefits for pressure flow, low power consumption and low noise level, ideal for commercial and industrial applications. Typical applications include either supply or exhaust service for ducted systems in schools, theaters, gymnasiums, manufacturing plants, hotels, office buildings, restaurant hoods, and many other general ventilation applications.

The turbine performance, minimizes unnecessary energy losses resulting in a system with high efficiency.

Its design, manufacture and testing guarantee a long operating life with low maintenance. Also having great versatility in arrangements, and available positions with a complete series of mounting accessories for installation and proper operation of equipment for each application.

The mechanical design and construction determines the maximum operating speed and power. The performance ranges shown on the following pages comply with the Class I operating limits as defined in AMCA standard 99.



Models CM & CMRHUL are available in our Quickship program. Many of the sizes are available for 10-day shipping from stock.

1 year fan housing warranty, 1 year motor warranty

All specifications are subject to change without notice unless approved in submittal by Soler & Palau USA.

STANDARD CONSTRUCTION FEATURES

Inlet/L-Flange (Standard): This standard feature allows for easy duct attachment. The inlet collar allows the fan to be removed with minimal disconnecting of the duct work.

Weather cover (Standard): Sheet metal ventilated enclosure for the motor, shaft, belts and drives for safety and weather protection.

Access door (Standard): This standard feature is a bolted access door that allows inspection or cleaning of the wheel compartment.

Threaded Drain Fitting (Standard): This standard feature is a 3/4" I.P.S. coupling positioned at the lowest point in fan housing to drain moisture from the bottom of the fan housing.

Mounting Rails (Standard): Set of galvanized steel rails for easy roof mounting of all units.

cULus705 (Standard on CM Units): For electrical reliability. Includes standard construction features listed above and cULus705 label. Clockwise or counter clockwise top horizontal (CW-TH or CCW-TH) discharge configuration are standard but other positions are available (must specify discharge orientation on order).

cULus762 (Standard on CM-RHUL units): For use in grease laden air or temperatures up to 400 degrees F. Ships with standard construction features listed above and cULus762 label. Clockwise or counter clockwise upblast (CW-UB or CCW-UB) discharge configuration are standard but top angular up (CW-TAU and CCW-TAU) positions are also available (must specify discharge orientation on order).

cULus793 (Standard on CM-HT units): Listed for emergency heat and smoke removal. Designed and UL Listed to withstand inlet temperatures of 500°F for 4 hours and 1000°F for 45 minutes. With this option the fan ships with standard construction features listed above, heat slinger, and cULus793 label. Clockwise or counter clockwise upblast (CW-UB or CCW-UB) discharge configuration are standard but other positions are also available (must specify discharge orientation on order).

ACCESSORIES/OPTIONS

Inlet/outlet Guard (Option): Heavy-gauge wire protects people and the fan entrance from unwanted debris in nonducted installations. Outlet Guard comes with outlet flange. (Not for UL762 use).

Outlet Flange (Option): Required on the discharge for mounting of either the optional damper or the optional outlet screen.

U-flange inlet (Option): Available for easy connection to flanged ductwork.

Discharge damper (Option): Heavy-duty interconnecting blade design opens by velocity. It helps prevent the entry of unwanted objects. Outlet Flange is required (included with damper). Maximum temperature is 200 degrees F and maximum face velocity is 3500 FPM. (Not for UL762 use). Damper cannot be used with TAD, DB, & BAD positions.

RIS Vibration Pads (Option): Set of RIS (rubber in shear) or spring type isolators help reduce vibration, improve motion restraint, help provide proper leveling, reduce torque forces, and provide improved stability in the fan installation.

Spring Vibration Pads (Option): Set of spring pads, ship loose for field mounting.

Grease trough (Option): Allows grease to collect in an easy to service container keeping roof area clean. Design allows for water and grease separation.

Shaft seal (Option): Nonasbestos fibrous material is sandwiched between the fan housing and cover plate. It helps reduce heat and the transfer of air from the wheel compartment. Seal does not make the fan air or gas tight.

Disconnect (Option): Available in either open or rain tight enclosure and matches the motor electrical characteristics. Allows for fan electrical cut off for servicing or inspection safety. (Ships loose).

Heat Slinger (Option): An aluminum cooling disc mounted on the fan shaft between the inboard bearing and the fan housing. The disc dissipates heat conducted along the fan shaft, and it also promotes circulation in the motor compartment. The additional circulation in the motor compartment extends motor life, because it allows the motor to operate at lower temperatures. Heat Slinger comes standard when ordering cULus793 listing.

CONSTRUCTION/SPECIFICATION CHECKLIST

Type: UTILITY VENT SET

Type of Wheel: Backward Inclined

Rotation: CW and CCW

Sizes: 10, 12, 14, 16, 18, 20, 22, 24, 27, 30, 36

Construction

Housing & Drive Frame Structure

The unit is solidly built, housing joints are welded intervals (*continuous welding on request, contact factory for availability and delivery schedules*), this provides greater strength, accuracy on the boards and makes a robust unit, which is an added value.

Wheel

Backward inclined centrifugal wheel is constructed of steel blades protected with a polyester powder coat finish. All wheels are statically and dynamically balanced to ISO 1940 and AMCA 204-G2.5 standards.

Paint

The unit is subjected to a coil coating process, where the steel is treated chemically to ensure the adherence of the polyester paint. Subsequently, powder coating is bonded to the parts through an electrostatic process, where after baking the piece takes on its highest characteristics corrosion resistance, with great adhesion properties and impact resistance.

Shafts and Bearings

Turned, ground and polished allow steel shafts sized so the first critical speed is at least 30% over the maximum operating speed. Standard bearings are heavy-duty, self-aligning pillow block ball bearings with minimum L10 life in excess of 100,000 hours at maximum cataloged operating conditions.

Motors

Heavy-duty ball bearing motors are factory mounted on an adjustable base for ease of service and belt maintenance. Standard motor enclosures are available as Open Drip Proof (ODP), Totally Enclosed Fan Cooled (TEFC). Explosion Proof motors are available by special request.

Drives

V-belt drives are selected for a minimum safety factor of 150% of the driven horsepower. Cast iron motor pulleys are adjustable for final system balancing and are factory set to the required RPM range. Dual groove v-belt drives are standard for motors 5 HP thru 10 HP. Three groove v-belt drives are standard on 15 HP units.

Temperature

Standard operating temperature range for cULus 705 units is -20°F to 200°F. For fans with cULus 762 construction the range is -20°F to 400°F. For CM-HT models with cULus 793 listing for emergency heat and smoke removal, designed and UL Listed to withstand inlet temperatures of 500°F for 4 hours and 1000°F for 45 minutes.

cULus 762 Fan Installation

Model CM is available with the 762 grease listing from UL. The fan will operate with continuous airstream temperatures of 400°F. Per NFPA 96, the fan discharge must be at least 40 inches above the roof line and the duct must be of all welded construction with a minimum distance of 18 inches above the roof line.

PHYSICAL DATA

CM Model	Wheel Diameter (in.)	Wheel Weight (lbs.)	WR ² (lbs-ft ²)	Max. Wheel RPM	Max. Motor Frame Size	Fan Weight* (lbs.)
10	10-1/16	4	0.600	3850	145T	62
12	12-11/16	11	1.90	3200	184T	89
14	14-7/8	13	3.56	2800	184T	102
16	16	18	5.22	2500	184T	119
18	17-15/16	24	9.73	2200	213T	160
20	20-3/16	31	16.85	1950	213T	188
22	22-7/16	42	26.10	1800	215T	269
24	25-3/16	59	41.77	1500	215T	340
27	28-1/4	84	78.31	1350	254T	549
30	31-7/8	108	132.18	1200	256T	739
36	35-5/8	140	200	1050	284T	959

*Weight is fan only (without accessories, motors, bases, drives, etc.)

ELEVATED TEMPERATURE DERATE

When elevated temperatures are encountered, maximum RPMs shown above must be derated according to the following table.

Temperature (°F)	Standard Steel	
70	1.00	
200	0.98	Standard Temperature Range
300	0.96	
400	0.95	
500	0.90	High Temperature Range
600	0.86	

ROTATION AND DISCHARGE

The direction of rotation is determined from the drive side of the fan. The direction of discharge is determined in accordance with the diagrams below. The angle of discharge is referred to the horizontal axis of fan and designated in degrees above or below such standard reference axis. **Not all positions are available for all sizes, see chart below.**

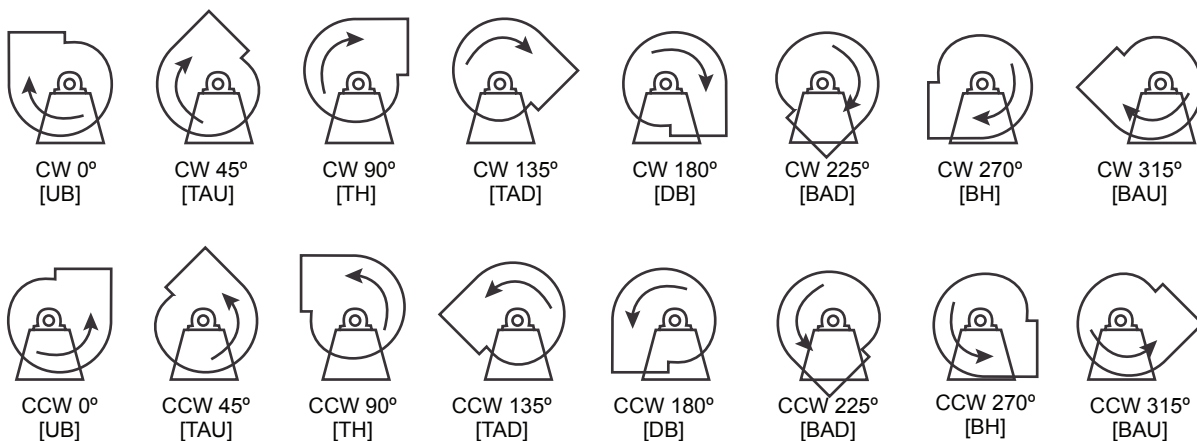

SIZE	OPTIONS OF ROTATIONS								TURN	
	UB	TAU	TH	TAD	DB	BAD	BH	BAU	CW	CCW
10-24	•	•	•	•	•	•	•	•	•	•
27-36	•	•	•						•	•

PERFORMANCE/DIMENSIONS

CM 10

Wheel Diameter: 10-1/16"
Outlet Area: 0.625 Sq. Ft.
Average Weight: CM - 62 lbs
Shaft Diameter: 3/4"
Tip Speed: 2.64 x RPM=FPM
Max Fan RPM: 2,998 RPM
Max Motor HP: 3/4 HP

CFM	OV	Static Pressure (Inches W.G.)													
		0.5		1		1.5		2		2.5		3		3.5	
		RPM	BHP	RPM	BHP	RPM	BHP	RPM	BHP	RPM	BHP	RPM	BHP	RPM	BHP
499	800	1316	0.07	1655	0.12	1939	0.18	-	-	-	-	-	-	-	-
531	850	1353	0.07	1682	0.13	1962	0.19	-	-	-	-	-	-	-	-
562	900	1392	0.08	1710	0.14	1986	0.20	2229	0.27	-	-	-	-	-	-
593	950	1431	0.08	1740	0.15	2011	0.21	2251	0.29	-	-	-	-	-	-
624	1000	1472	0.09	1772	0.16	2037	0.23	2274	0.30	2490	0.38	-	-	-	-
656	1050	1513	0.10	1804	0.17	2065	0.24	2299	0.31	2511	0.40	-	-	-	-
687	1100	1556	0.11	1839	0.18	2093	0.25	2324	0.33	2534	0.41	2729	0.50	-	-
718	1150	1600	0.12	1875	0.19	2123	0.27	2350	0.35	2558	0.43	2751	0.52	-	-
749	1200	1643	0.13	1912	0.20	2154	0.28	2377	0.36	2583	0.45	2774	0.54	2953	0.64
780	1250	1687	0.14	1950	0.21	2186	0.30	2405	0.38	2608	0.47	2798	0.56	2975	0.66
812	1300	1732	0.15	1989	0.23	2219	0.31	2435	0.40	2635	0.49	2822	0.58	2998	0.68
843	1350	1776	0.16	2029	0.24	2254	0.33	2465	0.42	2662	0.51	2847	0.61	-	-
874	1400	1820	0.17	2070	0.26	2290	0.34	2496	0.44	2691	0.53	2873	0.63	-	-
905	1450	1864	0.18	2111	0.27	2327	0.36	2528	0.46	2720	0.56	2900	0.66	-	-
936	1500	1908	0.20	2153	0.29	2365	0.38	2562	0.48	2750	0.58	2928	0.68	-	-
968	1550	1953	0.21	2196	0.30	2404	0.40	2596	0.50	2781	0.61	2957	0.71	-	-
999	1600	1998	0.22	2239	0.32	2442	0.42	2632	0.52	2813	0.63	2987	0.74	-	-
1030	1650	2043	0.24	2283	0.34	2482	0.44	2669	0.54	2846	0.66	-	-	-	-
1061	1700	2089	0.25	2327	0.36	2523	0.46	2706	0.57	2880	0.68	-	-	-	-
1093	1750	2135	0.27	2371	0.38	2564	0.49	2745	0.59	2915	0.71	-	-	-	-
1124	1800	2181	0.29	2415	0.40	2606	0.51	2783	0.62	2951	0.74	-	-	-	-
1155	1850	2228	0.31	2459	0.42	2648	0.54	2822	0.65	-	-	-	-	-	-
1186	1900	2275	0.33	2503	0.45	2691	0.56	2862	0.68	-	-	-	-	-	-
1217	1950	2323	0.35	2547	0.47	2734	0.59	2902	0.70	-	-	-	-	-	-
1249	2000	2371	0.38	2591	0.49	2778	0.62	2943	0.74	-	-	-	-	-	-
1280	2050	2422	0.40	2635	0.52	2821	0.64	-	-	-	-	-	-	-	-
1311	2100	2470	0.43	2680	0.54	2865	0.67	-	-	-	-	-	-	-	-
1342	2150	2519	0.44	2724	0.57	2909	0.70	-	-	-	-	-	-	-	-
1373	2200	2568	0.47	2769	0.59	2954	0.74	-	-	-	-	-	-	-	-
1405	2250	2619	0.50	2814	0.60	-	-	-	-	-	-	-	-	-	-
1436	2300	2669	0.52	2859	0.65	-	-	-	-	-	-	-	-	-	-
1467	2350	2718	0.56	2905	0.68	-	-	-	-	-	-	-	-	-	-
1498	2400	2768	0.59	2950	0.71	-	-	-	-	-	-	-	-	-	-
1530	2450	2820	0.62	2996	0.75	-	-	-	-	-	-	-	-	-	-
1561	2500	2870	0.66	-	-	-	-	-	-	-	-	-	-	-	-
1592	2550	2920	0.68	-	-	-	-	-	-	-	-	-	-	-	-
1623	2600	2971	0.72	-	-	-	-	-	-	-	-	-	-	-	-

Performance certified is for installation type B - free inlet, ducted outlet. Performance ratings do not include the effects of appurtenances (accessories). Power rating (BHP) does not include transmission losses.



UL STANDARD 705
 UL STANDARD 762
 UL STANDARD 793

Optional - Must be specified

CM 12

Wheel Diameter: 12-11/16"
Outlet Area: 0.97 Sq. Ft.
Average Weight: CM - 89 lbs
Shaft Diameter: 1"
Tip Speed: 3.33 x RPM=FPM
Max Fan RPM: 2,873 RPM
Max Motor HP: 2 HP

CFM	OV	Static Pressure (Inches W.G.)																			
		0.5		1		1.5		2		2.5		3		3.5		4		4.5		5	
		RPM	BHP	RPM	BHP	RPM	BHP	RPM	BHP	RPM	BHP	RPM	BHP	RPM	BHP	RPM	BHP	RPM	BHP	RPM	BHP
778	800	1039	0.10	1309	0.19	1539	0.29	-	-	-	-	-	-	-	-	-	-	-	-	-	-
875	900	1095	0.12	1352	0.22	1572	0.33	1770	0.44	-	-	-	-	-	-	-	-	-	-	-	-
972	1000	1157	0.14	1399	0.25	1611	0.36	1801	0.48	1977	0.61	-	-	-	-	-	-	-	-	-	-
1069	1100	1220	0.17	1451	0.28	1654	0.40	1838	0.53	2008	0.67	2166	0.81	-	-	-	-	-	-	-	-
1118	1150	1253	0.18	1479	0.30	1678	0.42	1858	0.55	2025	0.69	2182	0.84	-	-	-	-	-	-	-	-
1166	1200	1286	0.20	1507	0.32	1701	0.44	1879	0.58	2043	0.72	2197	0.87	2343	1.03	-	-	-	-	-	-
1215	1250	1320	0.21	1536	0.34	1727	0.47	1901	0.61	2063	0.75	2215	0.91	2359	1.07	-	-	-	-	-	-
1264	1300	1355	0.23	1566	0.36	1753	0.49	1924	0.63	2083	0.78	2233	0.94	2375	1.10	2511	1.27	-	-	-	-
1312	1350	1389	0.25	1596	0.38	1779	0.52	1947	0.66	2104	0.81	2252	0.97	2392	1.14	2526	1.31	2654	1.49	-	-
1361	1400	1424	0.27	1626	0.40	1807	0.54	1972	0.69	2126	0.85	2272	1.01	2411	1.18	2543	1.36	2669	1.54	-	-
1409	1450	1459	0.29	1658	0.42	1834	0.57	1997	0.72	2149	0.88	2293	1.05	2429	1.22	2560	1.40	2685	1.58	2806	1.77
1458	1500	1496	0.31	1690	0.45	1863	0.60	2023	0.75	2173	0.92	2314	1.09	2449	1.26	2578	1.45	2702	1.63	2821	1.83
1507	1550	1532	0.33	1722	0.48	1892	0.63	2050	0.79	2197	0.95	2337	1.13	2470	1.31	2597	1.49	2720	1.68	2838	1.88
1555	1600	1568	0.35	1755	0.50	1921	0.66	2077	0.82	2222	0.99	2360	1.17	2491	1.35	2617	1.54	2738	1.73	2855	1.93
1604	1650	1604	0.38	1788	0.53	1952	0.69	2105	0.86	2248	1.03	2384	1.21	2513	1.40	2637	1.59	2757	1.79	2873	1.99
1652	1700	1641	0.40	1820	0.56	1983	0.73	2133	0.90	2274	1.07	2408	1.26	2535	1.45	2658	1.64	2777	1.84	-	-
1701	1750	1678	0.43	1855	0.59	2014	0.76	2162	0.93	2301	1.12	2433	1.30	2559	1.50	2680	1.69	2797	1.90	-	-
1750	1800	1715	0.46	1889	0.63	2046	0.80	2191	0.98	2328	1.16	2459	1.35	2583	1.55	2703	1.75	2819	1.96	-	-
1798	1850	1753	0.49	1923	0.66	2077	0.84	2221	1.02	2356	1.20	2484	1.40	2607	1.60	2726	1.80	2840	2.00	-	-
1847	1900	1791	0.52	1958	0.70	2110	0.87	2251	1.06	2384	1.25	2511	1.45	2632	1.65	2750	1.86	-	-	-	-
1895	1950	1828	0.55	1993	0.73	2142	0.92	2281	1.10	2413	1.30	2538	1.50	2658	1.71	2774	1.92	-	-	-	-
1944	2000	1866	0.59	2028	0.77	2175	0.96	2313	1.15	2442	1.35	2566	1.55	2684	1.76	2798	1.98	-	-	-	-
1993	2050	1905	0.62	2064	0.81	2209	1.00	2344	1.20	2472	1.40	2594	1.61	2711	1.82	-	-	-	-	-	-
2090	2150	1981	0.70	2136	0.90	2276	1.10	2408	1.30	2532	1.51	2651	1.73	2766	1.95	-	-	-	-	-	-
2138	2200	2019	0.74	2171	0.94	2310	1.14	2440	1.35	2563	1.57	2680	1.79	2793	2.00	-	-	-	-	-	-
2187	2250	2058	0.78	2208	0.99	2344	1.20	2473	1.41	2594	1.63	2710	1.85	-	-	-	-	-	-	-	-
2236	2300	2097	0.83	2244	1.04	2379	1.25	2506	1.47	2626	1.69	2741	1.91	-	-	-	-	-	-	-	-
2284	2350	2136	0.87	2280	1.09	2414	1.30	2539	1.52	2657	1.75	2770	1.98	-	-	-	-	-	-	-	-
2333	2400	2175	0.92	2318	1.14	2449	1.36	2572	1.58	2690	1.81	-	-	-	-	-	-	-	-	-	-
2381	2450	2213	0.97	2355	1.19	2484	1.42	2606	1.64	2721	1.88	-	-	-	-	-	-	-	-	-	-
2430	2500	2252	1.02	2392	1.25	2520	1.48	2640	1.71	2754	1.95	-	-	-	-	-	-	-	-	-	-
2479	2550	2292	1.07	2429	1.30	2556	1.54	2674	1.78	-	-	-	-	-	-	-	-	-	-	-	-
2527	2600	2331	1.13	2466	1.36	2591	1.60	2708	1.84	-	-	-	-	-	-	-	-	-	-	-	-
2576	2650	2371	1.19	2504	1.43	2627	1.67	2743	1.91	-	-	-	-	-	-	-	-	-	-	-	-
2673	2750	2450	1.30	2579	1.55	2700	1.81	-	-	-	-	-	-	-	-	-	-	-	-	-	-
2722	2800	2490	1.37	2617	1.62	2737	1.88	-	-	-	-	-	-	-	-	-	-	-	-	-	-
2770	2850	2529	1.43	2655	1.69	2772	1.95	-	-	-	-	-	-	-	-	-	-	-	-	-	-
2819	2900	2569	1.50	2694	1.76	-	-	-	-	-	-	-	-	-	-	-	-	-	-	-	-
2867	2950	2608	1.57	2732	1.84	-	-	-	-	-	-	-	-	-	-	-	-	-	-	-	-
2916	3000	2649	1.64	2770	1.91	-	-	-	-	-	-	-	-	-	-	-	-	-	-	-	-
2965	3050	2689	1.72	2809	1.99	-	-	-	-	-	-	-	-	-	-	-	-	-	-	-	-
3013	3100	2729	1.79	-	-	-	-	-	-	-	-	-	-	-	-	-	-	-	-	-	-
3110	3200	2808	1.95	-	-	-	-	-	-	-	-	-	-	-	-	-	-	-	-	-	-

Performance certified is for installation type B - free inlet, ducted outlet.
 Performance ratings do not include the effects of appurtenances (accessories).
 Power rating (BHP) does not include transmission losses.



Soler & Palau USA, Div. of Soler & Palau Ventilation Group certifies that the Models CM shown herein are licensed to bear the AMCA Seal (except CM10). The ratings shown are based on test and procedures performed in accordance with AMCA Publication 211 and AMCA Publication 311 and comply with the requirement of the AMCA Certified Ratings Program.



UL STANDARD 705
UL STANDARD 762
UL STANDARD 793
 Optional - Must be specified



CM 14

Wheel Diameter: 14-7/8"
Outlet Area: 1.20 Sq. Ft.
Average Weight: CM - 102 lbs
Shaft Diameter: 1"
Tip Speed: 3.74 x RPM=FPM
Max Fan RPM: 2,672 RPM
Max Motor HP: 3 HP

CFM	OV	Static Pressure (Inches W.G.)																			
		0.5		1		1.5		2		2.5		3		3.5		4		4.5		5	
		RPM	BHP	RPM	BHP	RPM	BHP	RPM	BHP	RPM	BHP	RPM	BHP	RPM	BHP	RPM	BHP	RPM	BHP	RPM	BHP
960	800	907	0.12	1143	0.22	1350	0.34	-	-	-	-	-	-	-	-	-	-	-	-	-	-
1080	900	958	0.15	1179	0.26	1375	0.38	1554	0.51	-	-	-	-	-	-	-	-	-	-	-	-
1200	1000	1014	0.17	1221	0.29	1407	0.42	1577	0.56	1736	0.71	-	-	-	-	-	-	-	-	-	-
1320	1100	1072	0.21	1267	0.33	1444	0.47	1606	0.62	1759	0.77	1903	0.94	-	-	-	-	-	-	-	-
1380	1150	1101	0.22	1292	0.35	1464	0.49	1623	0.65	1772	0.81	1913	0.98	2048	1.15	-	-	-	-	-	-
1440	1200	1132	0.24	1317	0.38	1485	0.52	1640	0.68	1787	0.84	1926	1.01	2058	1.19	-	-	-	-	-	-
1500	1250	1162	0.26	1344	0.40	1507	0.55	1659	0.71	1802	0.88	1939	1.05	2069	1.24	2193	1.43	-	-	-	-
1560	1300	1193	0.28	1370	0.43	1530	0.58	1679	0.74	1819	0.91	1953	1.09	2081	1.28	2203	1.47	-	-	-	-
1620	1350	1224	0.31	1398	0.45	1554	0.61	1699	0.78	1837	0.95	1968	1.13	2094	1.33	2215	1.52	2331	1.73	-	-
1680	1400	1256	0.33	1425	0.48	1578	0.64	1721	0.81	1856	0.99	1985	1.18	2108	1.37	2227	1.57	2342	1.78	2452	2.00
1740	1450	1288	0.36	1454	0.51	1603	0.68	1743	0.85	1875	1.03	2002	1.22	2123	1.42	2240	1.63	2353	1.84	2463	2.06
1800	1500	1320	0.38	1483	0.54	1629	0.71	1766	0.89	1896	1.08	2020	1.27	2140	1.47	2255	1.68	2366	1.90	2474	2.12
1860	1550	1352	0.41	1512	0.58	1655	0.75	1790	0.93	1917	1.12	2039	1.32	2157	1.52	2270	1.74	2380	1.96	2486	2.18
1920	1600	1385	0.44	1542	0.61	1682	0.79	1814	0.97	1939	1.17	2059	1.37	2174	1.58	2286	1.79	2394	2.02	2499	2.25
1980	1650	1418	0.47	1571	0.65	1710	0.83	1839	1.02	1962	1.22	2080	1.42	2193	1.63	2303	1.85	2410	2.08	2513	2.31
2040	1700	1451	0.51	1602	0.69	1738	0.87	1864	1.06	1985	1.27	2101	1.48	2213	1.69	2321	1.92	2426	2.14	2528	2.38
2100	1750	1484	0.54	1632	0.72	1766	0.92	1891	1.11	2009	1.32	2123	1.53	2233	1.75	2339	1.98	2443	2.21	2543	2.45
2160	1800	1517	0.58	1663	0.77	1794	0.96	1917	1.16	2034	1.37	2146	1.59	2254	1.81	2359	2.04	2460	2.28	2560	2.52
2220	1850	1551	0.61	1694	0.81	1823	1.01	1944	1.22	2059	1.43	2169	1.65	2275	1.88	2378	2.11	2479	2.35	2577	2.60
2340	1950	1618	0.70	1757	0.90	1882	1.11	1999	1.33	2110	1.55	2217	1.78	2320	2.01	2420	2.25	2518	2.50	2613	2.75
2400	2000	1652	0.74	1788	0.95	1912	1.17	2027	1.39	2137	1.61	2242	1.84	2343	2.08	2442	2.33	2538	2.58	2632	2.84
2460	2050	1686	0.79	1821	1.00	1942	1.22	2056	1.45	2164	1.68	2267	1.91	2367	2.15	2465	2.40	2559	2.66	2652	2.92
2520	2100	1720	0.84	1853	1.06	1973	1.28	2084	1.51	2191	1.74	2293	1.98	2392	2.23	2487	2.48	2581	2.74	2672	3.00
2580	2150	1754	0.89	1885	1.11	2003	1.34	2113	1.57	2218	1.81	2319	2.06	2416	2.31	2511	2.56	2603	2.82	-	-
2640	2200	1789	0.94	1917	1.17	2034	1.40	2142	1.64	2246	1.88	2345	2.13	2441	2.38	2534	2.64	2626	2.91	-	-
2700	2250	1823	0.99	1950	1.23	2065	1.47	2172	1.71	2274	1.96	2372	2.21	2467	2.47	2559	2.73	2649	3.00	-	-
2760	2300	1857	1.05	1983	1.29	2096	1.53	2202	1.78	2303	2.03	2399	2.29	2493	2.55	2584	2.82	-	-	-	-
2880	2400	1927	1.17	2049	1.42	2159	1.68	2262	1.93	2360	2.19	2455	2.46	2546	2.73	2634	3.00	-	-	-	-
3000	2500	1996	1.30	2115	1.56	2223	1.83	2323	2.09	2419	2.36	2511	2.63	2600	2.91	-	-	-	-	-	-
3060	2550	2031	1.37	2148	1.64	2255	1.91	2355	2.18	2449	2.45	2540	2.73	-	-	-	-	-	-	-	-
3120	2600	2066	1.44	2182	1.71	2287	1.99	2386	2.26	2479	2.54	2569	2.82	-	-	-	-	-	-	-	-
3180	2650	2101	1.51	2216	1.79	2320	2.07	2417	2.35	2509	2.64	2598	2.92	-	-	-	-	-	-	-	-
3240	2700	2136	1.59	2249	1.87	2352	2.16	2448	2.44	2539	2.73	-	-	-	-	-	-	-	-	-	-
3300	2750	2171	1.66	2283	1.96	2385	2.25	2480	2.54	2570	2.83	-	-	-	-	-	-	-	-	-	-
3360	2800	2206	1.75	2317	2.04	2418	2.34	2511	2.64	2601	2.93	-	-	-	-	-	-	-	-	-	-
3420	2850	2241	1.83	2351	2.13	2450	2.43	2544	2.74	-	-	-	-	-	-	-	-	-	-	-	-
3480	2900	2276	1.92	2385	2.23	2483	2.53	2575	2.84	-	-	-	-	-	-	-	-	-	-	-	-
3540	2950	2312	2.01	2419	2.32	2516	2.63	2607	2.94	-	-	-	-	-	-	-	-	-	-	-	-
3600	3000	2347	2.10	2453	2.42	2549	2.74	-	-	-	-	-	-	-	-	-	-	-	-	-	-
3720	3100	2418	2.29	2521	2.63	2616	2.95	-	-	-	-	-	-	-	-	-	-	-	-	-	-
3840	3200	2489	2.50	2590	2.84	-	-	-	-	-	-	-	-	-	-	-	-	-	-	-	-
3960	3300	2560	2.72	-	-	-	-	-	-	-	-	-	-	-	-	-	-	-	-	-	-
4020	3350	2596	2.83	-	-	-	-	-	-	-	-	-	-	-	-	-	-	-	-	-	-
4080	3400	2631	2.95	-	-	-	-	-	-	-	-	-	-	-	-	-	-	-	-	-	-

Performance certified is for installation type B - free inlet, ducted outlet.
 Performance ratings do not include the effects of appurtenances (accessories).
 Power rating (BHP) does not include transmission losses.



Soler & Palau USA, Div. of Soler & Palau Ventilation Group certifies that the Models CM shown herein are licensed to bear the AMCA Seal (except CM10). The ratings shown are based on test and procedures performed in accordance with AMCA Publication 211 and AMCA Publication 311 and comply with the requirement of the AMCA Certified Ratings Program.



UL STANDARD 705
 UL STANDARD 762
 UL STANDARD 793
 Optional - Must be specified



CM 16

Wheel Diameter: 16"
Outlet Area: 1.49 Sq. Ft.
Average Weight: CM - 119 lbs
Shaft Diameter: 1"
Tip Speed: 4.19 x RPM=FPM
Max Fan RPM: 2,268 RPM
Max Motor HP: 3 HP

CFM	OV	Static Pressure (Inches W.G.)																			
		0.5		1		1.5		2		2.5		3		3.5		4		4.5		5	
		RPM	BHP	RPM	BHP	RPM	BHP	RPM	BHP	RPM	BHP	RPM	BHP	RPM	BHP	RPM	BHP	RPM	BHP	RPM	BHP
1192	800	816	0.15	1026	0.28	1209	0.43	-	-	-	-	-	-	-	-	-	-	-	-	-	-
1341	900	863	0.18	1060	0.32	1234	0.48	1391	0.65	-	-	-	-	-	-	-	-	-	-	-	-
1416	950	887	0.20	1079	0.34	1248	0.50	1402	0.68	-	-	-	-	-	-	-	-	-	-	-	-
1490	1000	912	0.22	1098	0.37	1263	0.53	1414	0.71	1554	0.90	-	-	-	-	-	-	-	-	-	-
1639	1100	964	0.26	1141	0.42	1297	0.59	1442	0.78	1577	0.98	1704	1.19	-	-	-	-	-	-	-	-
1788	1200	1017	0.30	1185	0.47	1335	0.66	1474	0.85	1603	1.06	1726	1.28	1843	1.51	-	-	-	-	-	-
1863	1250	1045	0.33	1209	0.50	1356	0.69	1491	0.89	1618	1.11	1739	1.33	1853	1.56	1963	1.80	-	-	-	-
1937	1300	1072	0.35	1233	0.53	1376	0.73	1509	0.93	1634	1.15	1752	1.38	1865	1.62	1973	1.86	-	-	-	-
2012	1350	1100	0.38	1258	0.57	1398	0.77	1528	0.98	1650	1.20	1767	1.43	1878	1.68	1985	1.93	2087	2.19	-	-
2086	1400	1128	0.41	1283	0.60	1420	0.81	1547	1.02	1668	1.25	1782	1.49	1891	1.73	1996	1.99	2098	2.25	2195	2.52
2161	1450	1156	0.44	1308	0.64	1443	0.85	1568	1.07	1686	1.30	1798	1.55	1906	1.80	2009	2.06	2109	2.33	2206	2.60
2235	1500	1184	0.48	1334	0.68	1466	0.89	1589	1.12	1704	1.36	1815	1.60	1921	1.86	2023	2.12	2121	2.40	2216	2.68
2310	1550	1213	0.51	1360	0.72	1490	0.94	1611	1.17	1724	1.41	1833	1.67	1937	1.93	2037	2.19	2134	2.47	2228	2.76
2384	1600	1242	0.55	1386	0.76	1514	0.99	1632	1.22	1744	1.47	1851	1.73	1953	1.99	2052	2.27	2148	2.55	2241	2.84
2459	1650	1271	0.59	1413	0.81	1539	1.04	1655	1.28	1765	1.53	1870	1.79	1971	2.06	2068	2.34	2163	2.63	2254	2.92
2533	1700	1300	0.63	1440	0.86	1564	1.09	1678	1.34	1786	1.59	1889	1.86	1989	2.13	2085	2.42	2178	2.71	2268	3.00
2608	1750	1329	0.67	1467	0.91	1589	1.15	1702	1.40	1808	1.66	1910	1.93	2007	2.21	2102	2.50	2194	2.79	-	-
2682	1800	1358	0.72	1494	0.96	1614	1.20	1725	1.46	1830	1.73	1930	2.00	2026	2.29	2120	2.58	2210	2.88	-	-
2757	1850	1388	0.77	1522	1.01	1641	1.26	1750	1.53	1853	1.80	1951	2.08	2046	2.37	2138	2.66	2227	2.97	-	-
2831	1900	1418	0.82	1550	1.07	1666	1.33	1774	1.59	1876	1.87	1973	2.15	2067	2.45	2157	2.75	-	-	-	-
2906	1950	1448	0.87	1578	1.13	1693	1.39	1799	1.66	1899	1.94	1995	2.23	2087	2.53	2177	2.84	-	-	-	-
2980	2000	1477	0.92	1606	1.19	1719	1.46	1824	1.74	1923	2.02	2017	2.32	2108	2.62	2196	2.93	-	-	-	-
3055	2050	1508	0.98	1634	1.25	1747	1.53	1850	1.81	1947	2.10	2040	2.40	2130	2.71	-	-	-	-	-	-
3129	2100	1537	1.04	1663	1.32	1773	1.60	1875	1.89	1972	2.19	2063	2.49	2152	2.80	-	-	-	-	-	-
3204	2150	1567	1.10	1691	1.39	1801	1.67	1901	1.97	1996	2.27	2087	2.58	2174	2.90	-	-	-	-	-	-
3278	2200	1598	1.17	1720	1.46	1828	1.75	1927	2.05	2021	2.36	2111	2.68	2197	3.00	-	-	-	-	-	-
3353	2250	1628	1.23	1749	1.53	1856	1.83	1954	2.14	2047	2.45	2135	2.77	-	-	-	-	-	-	-	-
3427	2300	1658	1.30	1778	1.61	1883	1.92	1980	2.23	2072	2.55	2159	2.87	-	-	-	-	-	-	-	-
3502	2350	1689	1.38	1807	1.69	1911	2.00	2007	2.32	2098	2.64	2184	2.98	-	-	-	-	-	-	-	-
3576	2400	1719	1.45	1836	1.77	1939	2.09	2034	2.41	2124	2.74	-	-	-	-	-	-	-	-	-	-
3651	2450	1750	1.53	1865	1.86	1967	2.18	2062	2.51	2150	2.85	-	-	-	-	-	-	-	-	-	-
3725	2500	1780	1.61	1894	1.95	1996	2.28	2089	2.61	2176	2.95	-	-	-	-	-	-	-	-	-	-
3800	2550	1811	1.70	1924	2.04	2024	2.38	2116	2.72	-	-	-	-	-	-	-	-	-	-	-	-
3874	2600	1841	1.79	1953	2.13	2053	2.48	2143	2.82	-	-	-	-	-	-	-	-	-	-	-	-
3949	2650	1872	1.88	1983	2.23	2081	2.58	2171	2.94	-	-	-	-	-	-	-	-	-	-	-	-
4023	2700	1903	1.97	2013	2.33	2110	2.69	-	-	-	-	-	-	-	-	-	-	-	-	-	-
4098	2750	1934	2.07	2042	2.44	2139	2.80	-	-	-	-	-	-	-	-	-	-	-	-	-	-
4172	2800	1964	2.17	2072	2.55	2168	2.92	-	-	-	-	-	-	-	-	-	-	-	-	-	-
4247	2850	1995	2.27	2102	2.66	-	-	-	-	-	-	-	-	-	-	-	-	-	-	-	-
4321	2900	2026	2.38	2132	2.77	-	-	-	-	-	-	-	-	-	-	-	-	-	-	-	-
4470	3000	2088	2.61	2192	3.00	-	-	-	-	-	-	-	-	-	-	-	-	-	-	-	-
4545	3050	2119	2.73	-	-	-	-	-	-	-	-	-	-	-	-	-	-	-	-	-	-
4619	3100	2150	2.85	-	-	-	-	-	-	-	-	-	-	-	-	-	-	-	-	-	-
4694	3150	2182	2.97	-	-	-	-	-	-	-	-	-	-	-	-	-	-	-	-	-	-

Performance certified is for installation type B - free inlet, ducted outlet.
 Performance ratings do not include the effects of appurtenances (accessories).
 Power rating (BHP) does not include transmission losses.



Soler & Palau USA, Div. of Soler & Palau Ventilation Group certifies that the Models CM shown herein are licensed to bear the AMCA Seal (except CM10). The ratings shown are based on test and procedures performed in accordance with AMCA Publication 211 and AMCA Publication 311 and comply with the requirement of the AMCA Certified Ratings Program.



UL STANDARD 705
 UL STANDARD 762
 UL STANDARD 793

Optional - Must be specified

CM 18

Wheel Diameter: 17-15/16"
Outlet Area: 1.88 Sq. Ft.
Average Weight: CM - 160 lbs
Shaft Diameter: 1-1/2"
Tip Speed: 4.69 x RPM=FPM
Max Fan RPM: 2,137 RPM
Max Motor HP: 5 HP

CFM	OV	Static Pressure (Inches W.G.)																			
		0.5		1		1.5		2		2.5		3		3.5		4		4.5		5	
		RPM	BHP	RPM	BHP	RPM	BHP	RPM	BHP	RPM	BHP	RPM	BHP	RPM	BHP	RPM	BHP	RPM	BHP	RPM	BHP
1504	800	713	0.19	900	0.35	1062	0.52	-	-	-	-	-	-	-	-	-	-	-	-	-	-
1692	900	753	0.22	929	0.39	1083	0.58	1222	0.79	-	-	-	-	-	-	-	-	-	-	-	-
1786	950	774	0.24	945	0.42	1095	0.61	1232	0.83	-	-	-	-	-	-	-	-	-	-	-	-
1880	1000	795	0.27	961	0.45	1108	0.65	1242	0.87	1366	1.10	-	-	-	-	-	-	-	-	-	-
1974	1050	817	0.29	979	0.48	1122	0.68	1253	0.91	1375	1.14	-	-	-	-	-	-	-	-	-	-
2162	1150	862	0.34	1016	0.54	1152	0.76	1278	0.99	1395	1.24	1506	1.50	-	-	-	-	-	-	-	-
2350	1250	909	0.40	1055	0.62	1186	0.85	1307	1.09	1420	1.35	1526	1.62	1628	1.90	-	-	-	-	-	-
2444	1300	932	0.43	1076	0.66	1204	0.89	1322	1.14	1433	1.41	1538	1.68	1638	1.97	1734	2.27	-	-	-	-
2538	1350	956	0.47	1097	0.70	1222	0.94	1338	1.20	1447	1.46	1550	1.75	1649	2.04	1743	2.35	1834	2.66	-	-
2632	1400	981	0.50	1118	0.74	1241	0.99	1354	1.25	1461	1.53	1563	1.81	1660	2.11	1753	2.42	1843	2.75	-	-
2726	1450	1005	0.54	1140	0.79	1260	1.04	1372	1.31	1477	1.59	1577	1.88	1672	2.19	1764	2.50	1852	2.83	1938	3.17
2820	1500	1030	0.58	1162	0.83	1280	1.10	1390	1.37	1493	1.66	1591	1.96	1685	2.27	1775	2.59	1863	2.92	1947	3.26
3008	1600	1080	0.67	1207	0.94	1321	1.21	1426	1.50	1526	1.80	1621	2.11	1713	2.43	1800	2.76	1885	3.10	1967	3.46
3102	1650	1105	0.72	1230	0.99	1342	1.28	1446	1.57	1544	1.87	1637	2.19	1727	2.52	1814	2.85	1898	3.20	1979	3.56
3196	1700	1130	0.77	1253	1.05	1363	1.34	1465	1.64	1562	1.95	1654	2.27	1743	2.61	1828	2.95	1910	3.30	1990	3.67
3290	1750	1156	0.82	1276	1.11	1385	1.41	1485	1.71	1580	2.03	1671	2.36	1758	2.70	1842	3.05	1924	3.41	2003	3.77
3384	1800	1182	0.88	1300	1.18	1407	1.48	1505	1.79	1599	2.11	1689	2.45	1774	2.79	1857	3.15	1938	3.51	2016	3.89
3572	1900	1233	1.00	1348	1.31	1451	1.63	1547	1.95	1638	2.29	1725	2.64	1808	2.99	1889	3.36	1967	3.73	2043	4.12
3666	1950	1259	1.06	1372	1.38	1474	1.71	1568	2.04	1658	2.38	1743	2.74	1826	3.10	1906	3.47	1983	3.85	2058	4.24
3760	2000	1286	1.13	1397	1.46	1497	1.79	1590	2.13	1678	2.48	1762	2.84	1844	3.21	1922	3.58	1999	3.97	2073	4.37
3948	2100	1338	1.27	1446	1.61	1543	1.96	1634	2.32	1720	2.68	1801	3.05	1881	3.43	1957	3.82	2032	4.22	2104	4.63
4042	2150	1364	1.34	1471	1.70	1566	2.05	1656	2.42	1741	2.79	1822	3.16	1900	3.55	1975	3.95	2049	4.35	2120	4.76
4136	2200	1391	1.42	1496	1.79	1590	2.15	1678	2.52	1762	2.90	1842	3.28	1919	3.67	1994	4.08	2066	4.49	2137	4.91
4324	2300	1444	1.59	1546	1.97	1638	2.35	1724	2.73	1805	3.12	1883	3.52	1959	3.93	2032	4.34	2102	4.77	-	-
4418	2350	1471	1.68	1571	2.07	1662	2.46	1747	2.85	1827	3.24	1905	3.65	1979	4.06	2051	4.48	2121	4.91	-	-
4512	2400	1498	1.77	1597	2.17	1686	2.56	1770	2.96	1850	3.37	1926	3.78	1999	4.20	2070	4.63	-	-	-	-
4606	2450	1524	1.87	1622	2.27	1711	2.68	1794	3.08	1872	3.50	1947	3.91	2020	4.34	2090	4.77	-	-	-	-
4700	2500	1551	1.97	1648	2.38	1735	2.79	1817	3.21	1895	3.63	1969	4.05	2041	4.49	2110	4.93	-	-	-	-
4794	2550	1578	2.07	1673	2.49	1760	2.91	1841	3.33	1917	3.76	1991	4.19	2062	4.63	-	-	-	-	-	-
4888	2600	1605	2.18	1699	2.61	1784	3.04	1865	3.47	1940	3.90	2013	4.34	2083	4.79	-	-	-	-	-	-
4982	2650	1632	2.29	1725	2.73	1809	3.16	1889	3.60	1964	4.04	2036	4.49	2105	4.94	-	-	-	-	-	-
5076	2700	1659	2.40	1751	2.85	1834	3.30	1913	3.74	1987	4.19	2058	4.65	-	-	-	-	-	-	-	-
5264	2800	1714	2.64	1803	3.11	1885	3.57	1961	4.03	2034	4.50	2104	4.97	-	-	-	-	-	-	-	-
5358	2850	1741	2.77	1829	3.25	1910	3.71	1986	4.19	2057	4.66	-	-	-	-	-	-	-	-	-	-
5452	2900	1768	2.90	1855	3.39	1935	3.86	2010	4.34	2081	4.82	-	-	-	-	-	-	-	-	-	-
5546	2950	1796	3.04	1882	3.53	1961	4.02	2035	4.50	2105	4.99	-	-	-	-	-	-	-	-	-	-
5640	3000	1823	3.18	1908	3.68	1986	4.17	2060	4.67	-	-	-	-	-	-	-	-	-	-	-	-
5828	3100	1878	3.47	1961	3.99	2037	4.50	-	-	-	-	-	-	-	-	-	-	-	-	-	-
6016	3200	1933	3.78	2014	4.32	2089	4.85	-	-	-	-	-	-	-	-	-	-	-	-	-	-
6204	3300	1988	4.11	2067	4.67	-	-	-	-	-	-	-	-	-	-	-	-	-	-	-	-
6298	3350	2016	4.28	2094	4.85	-	-	-	-	-	-	-	-	-	-	-	-	-	-	-	-
6392	3400	2043	4.46	-	-	-	-	-	-	-	-	-	-	-	-	-	-	-	-	-	-
6486	3450	2071	4.64	-	-	-	-	-	-	-	-	-	-	-	-	-	-	-	-	-	-

Performance certified is for installation type B - free inlet, ducted outlet.
 Performance ratings do not include the effects of appurtenances (accessories).
 Power rating (BHP) does not include transmission losses.



Soler & Palau USA, Div. of Soler & Palau Ventilation Group certifies that the Models CM shown herein are licensed to bear the AMCA Seal (except CM10). The ratings shown are based on test and procedures performed in accordance with AMCA Publication 211 and AMCA Publication 311 and comply with the requirement of the AMCA Certified Ratings Program.



UL STANDARD 705
UL STANDARD 762
UL STANDARD 793

Optional - Must be specified

CM 20

Wheel Diameter: 20-3/16"
Outlet Area: 2.33 Sq. Ft.
Average Weight: CM - 188 lbs
Shaft Diameter: 1-1/2"
Tip Speed: 5.26 x RPM=FPM
Max Fan RPM: 1,823 RPM
Max Motor HP: 5 HP

CFM	OV	Static Pressure (Inches W.G.)																			
		0.5		1		1.5		2		2.5		3		3.5		4		4.5		5	
		RPM	BHP	RPM	BHP	RPM	BHP	RPM	BHP	RPM	BHP	RPM	BHP	RPM	BHP	RPM	BHP	RPM	BHP	RPM	BHP
1864	800	635	0.22	804	0.42	950	0.64	-	-	-	-	-	-	-	-	-	-	-	-	-	-
2097	900	669	0.27	828	0.48	967	0.71	-	-	-	-	-	-	-	-	-	-	-	-	-	-
2330	1000	706	0.31	856	0.54	989	0.79	1110	1.05	-	-	-	-	-	-	-	-	-	-	-	-
2563	1100	744	0.37	887	0.61	1014	0.87	1130	1.15	1237	1.45	-	-	-	-	-	-	-	-	-	-
2680	1150	764	0.40	904	0.65	1027	0.92	1141	1.20	1247	1.51	1346	1.83	-	-	-	-	-	-	-	-
2796	1200	784	0.43	921	0.69	1042	0.96	1153	1.26	1257	1.57	1355	1.90	1447	2.24	-	-	-	-	-	-
2913	1250	805	0.47	938	0.73	1056	1.01	1165	1.32	1267	1.64	1364	1.97	1455	2.32	-	-	-	-	-	-
3029	1300	825	0.50	956	0.78	1072	1.07	1179	1.38	1279	1.70	1374	2.04	1464	2.40	1550	2.77	-	-	-	-
3146	1350	846	0.54	974	0.82	1088	1.12	1193	1.44	1291	1.77	1384	2.12	1473	2.48	1558	2.86	-	-	-	-
3262	1400	867	0.58	993	0.87	1104	1.18	1207	1.50	1304	1.84	1395	2.20	1483	2.57	1567	2.95	1647	3.35	-	-
3379	1450	889	0.63	1012	0.93	1121	1.24	1222	1.57	1317	1.92	1407	2.28	1493	2.66	1576	3.05	1655	3.45	1732	3.86
3495	1500	910	0.68	1031	0.98	1138	1.30	1237	1.64	1331	2.00	1419	2.37	1504	2.75	1586	3.14	1664	3.55	1740	3.97
3612	1550	932	0.72	1050	1.04	1156	1.37	1253	1.71	1345	2.08	1432	2.45	1516	2.84	1596	3.25	1674	3.66	1749	4.09
3728	1600	954	0.78	1070	1.10	1173	1.44	1269	1.79	1360	2.16	1446	2.54	1528	2.94	1607	3.35	1684	3.77	1758	4.21
3845	1650	976	0.83	1090	1.16	1192	1.51	1286	1.87	1375	2.25	1460	2.64	1541	3.04	1619	3.46	1695	3.89	1768	4.33
3961	1700	998	0.89	1110	1.23	1210	1.58	1303	1.95	1390	2.33	1474	2.73	1554	3.14	1631	3.57	1706	4.00	1778	4.45
4078	1750	1021	0.95	1131	1.30	1229	1.66	1320	2.04	1406	2.43	1489	2.83	1568	3.25	1644	3.68	1717	4.13	1789	4.58
4194	1800	1043	1.01	1151	1.37	1248	1.74	1338	2.12	1423	2.52	1504	2.94	1582	3.36	1657	3.80	1729	4.25	1800	4.71
4311	1850	1066	1.08	1172	1.44	1268	1.82	1356	2.22	1439	2.62	1519	3.04	1596	3.48	1670	3.92	1742	4.38	1811	4.85
4427	1900	1088	1.14	1193	1.52	1287	1.91	1374	2.31	1457	2.73	1535	3.15	1611	3.59	1684	4.05	1755	4.51	1823	4.99
4660	2000	1134	1.29	1235	1.69	1327	2.10	1411	2.51	1491	2.94	1568	3.38	1642	3.84	1713	4.31	1782	4.78	-	-
4777	2050	1156	1.37	1257	1.78	1347	2.19	1430	2.62	1509	3.06	1585	3.51	1658	3.97	1728	4.44	1796	4.93	-	-
4893	2100	1179	1.45	1278	1.87	1367	2.29	1450	2.73	1527	3.17	1602	3.63	1674	4.10	1743	4.58	-	-	-	-
5010	2150	1203	1.54	1300	1.96	1388	2.40	1469	2.84	1546	3.29	1619	3.76	1690	4.24	1759	4.73	-	-	-	-
5126	2200	1226	1.63	1322	2.06	1408	2.51	1488	2.96	1564	3.42	1637	3.89	1707	4.38	1775	4.87	-	-	-	-
5243	2250	1249	1.72	1344	2.17	1429	2.62	1508	3.08	1583	3.55	1655	4.03	1724	4.52	-	-	-	-	-	-
5359	2300	1272	1.82	1366	2.27	1450	2.73	1528	3.20	1602	3.68	1673	4.17	1741	4.67	-	-	-	-	-	-
5476	2350	1295	1.92	1388	2.38	1471	2.85	1548	3.33	1621	3.82	1691	4.31	1759	4.82	-	-	-	-	-	-
5592	2400	1319	2.02	1410	2.50	1492	2.98	1568	3.46	1641	3.96	1710	4.46	-	-	-	-	-	-	-	-
5709	2450	1342	2.13	1432	2.62	1513	3.10	1589	3.60	1660	4.10	1729	4.62	-	-	-	-	-	-	-	-
5825	2500	1366	2.24	1454	2.74	1535	3.24	1609	3.74	1680	4.25	1748	4.77	-	-	-	-	-	-	-	-
6058	2600	1413	2.48	1499	3.00	1578	3.51	1651	4.04	1720	4.57	-	-	-	-	-	-	-	-	-	-
6175	2650	1436	2.60	1522	3.13	1600	3.66	1672	4.19	1740	4.73	-	-	-	-	-	-	-	-	-	-
6291	2700	1460	2.73	1545	3.27	1621	3.81	1693	4.35	1760	4.90	-	-	-	-	-	-	-	-	-	-
6408	2750	1484	2.87	1567	3.42	1643	3.96	1714	4.51	-	-	-	-	-	-	-	-	-	-	-	-
6524	2800	1507	3.01	1590	3.56	1665	4.12	1735	4.68	-	-	-	-	-	-	-	-	-	-	-	-
6757	2900	1555	3.30	1636	3.88	1709	4.45	1778	5.03	-	-	-	-	-	-	-	-	-	-	-	-
6990	3000	1603	3.61	1682	4.21	1754	4.80	-	-	-	-	-	-	-	-	-	-	-	-	-	-
7107	3050	1627	3.77	1705	4.38	1776	4.99	-	-	-	-	-	-	-	-	-	-	-	-	-	-
7223	3100	1651	3.94	1728	4.56	-	-	-	-	-	-	-	-	-	-	-	-	-	-	-	-
7340	3150	1675	4.11	1751	4.74	-	-	-	-	-	-	-	-	-	-	-	-	-	-	-	-
7456	3200	1699	4.29	1774	4.93	-	-	-	-	-	-	-	-	-	-	-	-	-	-	-	-
7573	3250	1723	4.47	-	-	-	-	-	-	-	-	-	-	-	-	-	-	-	-	-	-
7689	3300	1747	4.66	-	-	-	-	-	-	-	-	-	-	-	-	-	-	-	-	-	-
7806	3350	1771	4.86	-	-	-	-	-	-	-	-	-	-	-	-	-	-	-	-	-	-

Performance certified is for installation type B - free inlet, ducted outlet.
 Performance ratings do not include the effects of appurtenances (accessories).
 Power rating (BHP) does not include transmission losses.



Soler & Palau USA, Div. of Soler & Palau Ventilation Group certifies that the Models CM shown herein are licensed to bear the AMCA Seal (except CM10). The ratings shown are based on test and procedures performed in accordance with AMCA Publication 211 and AMCA Publication 311 and comply with the requirement of the AMCA Certified Ratings Program.



UL STANDARD 705
UL STANDARD 762
UL STANDARD 793
 Optional - Must be specified



CM 22

Wheel Diameter: 22-7/16"
Outlet Area: 2.95 Sq. Ft.
Average Weight: CM - 269 lbs
Shaft Diameter: 1-1/2"
Tip Speed: 5.88 x RPM=FPM
Max Fan RPM: 1,716 RPM
Max Motor HP: 7-1/2 HP

CFM	OV	Static Pressure (Inches W.G.)																			
		0.5		1		1.5		2		2.5		3		3.5		4		4.5		5	
		RPM	BHP	RPM	BHP	RPM	BHP	RPM	BHP	RPM	BHP	RPM	BHP	RPM	BHP	RPM	BHP	RPM	BHP	RPM	BHP
2360	800	573	0.28	723	0.53	854	0.81	-	-	-	-	-	-	-	-	-	-	-	-	-	-
2655	900	604	0.34	746	0.60	870	0.90	-	-	-	-	-	-	-	-	-	-	-	-	-	-
2950	1000	637	0.40	772	0.68	890	0.99	998	1.33	-	-	-	-	-	-	-	-	-	-	-	-
3245	1100	672	0.47	800	0.77	913	1.10	1016	1.46	1112	1.83	-	-	-	-	-	-	-	-	-	-
3540	1200	709	0.55	831	0.87	939	1.22	1038	1.59	1130	1.99	1218	2.40	-	-	-	-	-	-	-	-
3688	1250	727	0.59	847	0.93	952	1.29	1049	1.67	1140	2.07	1226	2.49	1308	2.93	-	-	-	-	-	-
3835	1300	746	0.64	863	0.98	966	1.35	1062	1.74	1151	2.15	1235	2.58	1316	3.03	1393	3.49	-	-	-	-
3983	1350	765	0.69	880	1.04	981	1.42	1074	1.82	1162	2.24	1245	2.68	1325	3.14	1400	3.61	-	-	-	-
4130	1400	784	0.74	896	1.11	996	1.50	1088	1.90	1174	2.33	1256	2.78	1334	3.25	1409	3.73	1480	4.22	-	-
4278	1450	803	0.80	914	1.17	1011	1.57	1101	1.99	1186	2.43	1267	2.89	1343	3.36	1417	3.85	1488	4.36	-	-
4425	1500	822	0.86	931	1.24	1027	1.65	1116	2.08	1199	2.53	1278	2.99	1354	3.48	1426	3.98	1496	4.49	1564	5.02
4720	1600	862	0.98	967	1.39	1059	1.82	1145	2.27	1226	2.74	1302	3.22	1376	3.72	1446	4.24	1515	4.77	1581	5.32
4868	1650	881	1.05	985	1.47	1076	1.91	1160	2.37	1240	2.85	1315	3.34	1387	3.85	1457	4.38	1524	4.92	1590	5.47
5015	1700	901	1.12	1003	1.56	1093	2.01	1176	2.47	1254	2.96	1328	3.46	1400	3.98	1468	4.52	1535	5.07	1599	5.63
5163	1750	921	1.20	1022	1.64	1110	2.10	1192	2.58	1269	3.08	1342	3.59	1412	4.12	1480	4.66	1545	5.22	1609	5.80
5310	1800	941	1.28	1040	1.74	1127	2.21	1208	2.69	1284	3.20	1356	3.72	1425	4.26	1492	4.81	1557	5.38	1619	5.96
5605	1900	982	1.45	1078	1.93	1163	2.42	1241	2.93	1314	3.46	1385	4.00	1452	4.55	1517	5.13	1580	5.71	1641	6.31
5753	1950	1002	1.54	1097	2.03	1181	2.54	1258	3.06	1330	3.59	1400	4.14	1466	4.71	1530	5.29	1593	5.88	1653	6.49
5900	2000	1022	1.64	1116	2.14	1199	2.66	1275	3.18	1346	3.73	1415	4.29	1480	4.87	1544	5.46	1605	6.06	1665	6.68
6195	2100	1063	1.84	1155	2.37	1235	2.91	1309	3.46	1379	4.02	1446	4.60	1510	5.20	1572	5.81	1631	6.43	1690	7.07
6343	2150	1084	1.95	1174	2.49	1254	3.04	1327	3.60	1396	4.18	1462	4.77	1525	5.37	1586	5.99	1645	6.62	1703	7.27
6490	2200	1105	2.06	1194	2.62	1272	3.18	1345	3.75	1413	4.33	1478	4.93	1540	5.55	1601	6.18	1659	6.82	1716	7.47
6638	2250	1125	2.18	1213	2.75	1291	3.32	1363	3.90	1430	4.50	1494	5.11	1556	5.73	1616	6.37	1673	7.02	-	-
6785	2300	1146	2.30	1233	2.88	1310	3.47	1381	4.06	1447	4.66	1511	5.28	1572	5.92	1631	6.57	1688	7.23	-	-
7080	2400	1188	2.56	1273	3.17	1348	3.77	1417	4.39	1482	5.02	1544	5.66	1604	6.31	1662	6.98	-	-	-	-
7375	2500	1230	2.84	1313	3.47	1386	4.10	1454	4.74	1518	5.39	1578	6.05	1637	6.73	1693	7.41	-	-	-	-
7523	2550	1251	2.99	1333	3.63	1406	4.28	1473	4.93	1536	5.59	1596	6.26	1654	6.94	-	-	-	-	-	-
7670	2600	1272	3.14	1353	3.80	1425	4.46	1491	5.12	1554	5.79	1613	6.47	1671	7.16	-	-	-	-	-	-
7818	2650	1293	3.30	1373	3.97	1445	4.64	1510	5.31	1572	5.99	1631	6.69	1688	7.39	-	-	-	-	-	-
7965	2700	1314	3.47	1394	4.15	1464	4.83	1529	5.51	1590	6.21	1649	6.91	-	-	-	-	-	-	-	-
8260	2800	1356	3.81	1434	4.52	1503	5.22	1567	5.93	1627	6.65	1685	7.38	-	-	-	-	-	-	-	-
8555	2900	1399	4.18	1475	4.92	1543	5.65	1606	6.38	1665	7.12	-	-	-	-	-	-	-	-	-	-
8703	2950	1420	4.38	1496	5.13	1563	5.87	1625	6.61	1684	7.36	-	-	-	-	-	-	-	-	-	-
8850	3000	1441	4.58	1516	5.34	1583	6.09	1645	6.85	-	-	-	-	-	-	-	-	-	-	-	-
8998	3050	1463	4.78	1537	5.56	1603	6.33	1664	7.09	-	-	-	-	-	-	-	-	-	-	-	-
9145	3100	1484	4.99	1558	5.78	1623	6.56	1684	7.34	-	-	-	-	-	-	-	-	-	-	-	-
9293	3150	1505	5.21	1578	6.02	1643	6.81	1703	-	-	-	-	-	-	-	-	-	-	-	-	-
9440	3200	1527	5.44	1599	6.26	1663	7.06	1723	-	-	-	-	-	-	-	-	-	-	-	-	-
9735	3300	1570	5.91	1640	6.75	-	-	-	-	-	-	-	-	-	-	-	-	-	-	-	-
9883	3350	1591	6.16	1661	7.02	-	-	-	-	-	-	-	-	-	-	-	-	-	-	-	-
10030	3400	1613	6.41	1682	7.28	-	-	-	-	-	-	-	-	-	-	-	-	-	-	-	-
10325	3500	1656	6.94	-	-	-	-	-	-	-	-	-	-	-	-	-	-	-	-	-	-
10473	3550	1678	7.22	-	-	-	-	-	-	-	-	-	-	-	-	-	-	-	-	-	-
10620	3600	1699	7.50	-	-	-	-	-	-	-	-	-	-	-	-	-	-	-	-	-	-

Performance certified is for installation type B - free inlet, ducted outlet.
 Performance ratings do not include the effects of appurtenances (accessories).
 Power rating (BHP) does not include transmission losses.



Soler & Palau USA, Div. of Soler & Palau Ventilation Group certifies that the Models CM shown herein are licensed to bear the AMCA Seal (except CM10). The ratings shown are based on test and procedures performed in accordance with AMCA Publication 211 and AMCA Publication 311 and comply with the requirement of the AMCA Certified Ratings Program.



UL STANDARD 705
 UL STANDARD 762
 UL STANDARD 793
 Optional - Must be specified



CM 24

Wheel Diameter: 25-3/16"
Outlet Area: 3.70 Sq. Ft.
Average Weight: CM - 340 lbs
Shaft Diameter: 1-1/2"
Tip Speed: 6.60 x RPM=FPM
Max Fan RPM: 1,533 RPM
Max Motor HP: 10 HP

CFM	OV	Static Pressure (Inches W.G.)																			
		0.5		1		1.5		2		2.5		3		3.5		4		4.5		5	
		RPM	BHP	RPM	BHP	RPM	BHP	RPM	BHP	RPM	BHP	RPM	BHP	RPM	BHP	RPM	BHP	RPM	BHP	RPM	BHP
2960	800	495	0.34	631	0.64	-	-	-	-	-	-	-	-	-	-	-	-	-	-	-	-
3330	900	521	0.40	648	0.72	761	1.08	-	-	-	-	-	-	-	-	-	-	-	-	-	-
3700	1000	549	0.47	669	0.81	776	1.19	874	1.60	-	-	-	-	-	-	-	-	-	-	-	-
4070	1100	579	0.55	692	0.92	794	1.32	887	1.75	975	2.21	-	-	-	-	-	-	-	-	-	-
4440	1200	610	0.64	718	1.03	814	1.46	903	1.91	988	2.39	1068	2.90	-	-	-	-	-	-	-	-
4625	1250	626	0.70	731	1.10	825	1.53	913	2.00	995	2.49	1073	3.00	1148	3.54	-	-	-	-	-	-
4810	1300	642	0.75	744	1.16	836	1.61	922	2.08	1003	2.59	1080	3.11	1154	3.66	-	-	-	-	-	-
4995	1350	658	0.81	758	1.23	848	1.69	932	2.18	1012	2.69	1087	3.22	1159	3.78	1229	4.36	-	-	-	-
5180	1400	674	0.87	773	1.31	861	1.78	943	2.27	1021	2.79	1095	3.34	1166	3.91	1234	4.50	1300	5.10	-	-
5365	1450	691	0.93	787	1.38	874	1.86	954	2.37	1030	2.90	1103	3.46	1173	4.04	1240	4.64	1305	5.26	-	-
5550	1500	707	1.00	802	1.46	887	1.96	966	2.47	1040	3.02	1112	3.59	1181	4.18	1247	4.79	1311	5.41	1373	6.06
5735	1550	724	1.07	817	1.55	900	2.05	978	2.58	1051	3.14	1121	3.72	1189	4.32	1254	4.94	1317	5.58	1378	6.23
5920	1600	741	1.15	832	1.64	914	2.15	990	2.69	1062	3.26	1131	3.85	1197	4.46	1262	5.09	1324	5.74	1384	6.41
6290	1700	775	1.31	863	1.83	942	2.37	1015	2.93	1085	3.52	1152	4.13	1216	4.76	1278	5.41	1339	6.09	1397	6.77
6475	1750	792	1.40	879	1.93	957	2.48	1029	3.06	1097	3.66	1163	4.28	1226	4.92	1287	5.58	1347	6.26	1405	6.96
6660	1800	809	1.49	895	2.03	971	2.60	1042	3.19	1109	3.80	1174	4.43	1236	5.08	1297	5.76	1355	6.45	1412	7.16
6845	1850	827	1.58	911	2.14	986	2.72	1056	3.32	1122	3.94	1186	4.59	1247	5.25	1306	5.94	1364	6.64	1420	7.36
7030	1900	844	1.68	927	2.26	1001	2.85	1070	3.46	1135	4.10	1198	4.75	1258	5.42	1317	6.12	1373	6.83	1429	7.56
7215	1950	862	1.79	943	2.38	1016	2.98	1084	3.61	1148	4.25	1210	4.92	1269	5.60	1327	6.31	1383	7.03	1438	7.77
7400	2000	879	1.90	960	2.50	1032	3.12	1099	3.76	1162	4.41	1222	5.09	1281	5.79	1338	6.50	1393	7.24	1447	7.99
7585	2050	897	2.01	976	2.63	1047	3.26	1113	3.91	1175	4.58	1235	5.27	1293	5.98	1349	6.70	1404	7.45	1457	8.21
7770	2100	914	2.13	993	2.77	1063	3.41	1128	4.07	1189	4.75	1248	5.45	1305	6.17	1361	6.91	1414	7.67	1467	8.44
8140	2200	950	2.39	1026	3.05	1095	3.72	1158	4.41	1218	5.11	1275	5.84	1331	6.58	1384	7.34	1437	8.12	1488	8.91
8325	2250	968	2.52	1043	3.20	1111	3.89	1173	4.59	1232	5.30	1289	6.04	1344	6.79	1397	7.56	1448	8.35	1499	9.16
8510	2300	986	2.66	1060	3.36	1127	4.06	1188	4.77	1247	5.50	1303	6.25	1357	7.01	1409	7.79	1460	8.59	1510	9.41
8695	2350	1003	2.81	1077	3.52	1143	4.23	1204	4.96	1262	5.70	1317	6.46	1370	7.24	1422	8.03	1472	8.84	1522	9.67
8880	2400	1021	2.96	1094	3.69	1159	4.41	1220	5.15	1277	5.91	1331	6.68	1384	7.47	1435	8.27	1485	9.09	1533	9.93
9250	2500	1057	3.28	1129	4.04	1192	4.79	1251	5.56	1307	6.34	1360	7.14	1412	7.95	1461	8.78	1510	9.62	-	-
9620	2600	1094	3.63	1163	4.42	1225	5.20	1283	5.99	1338	6.80	1390	7.62	1440	8.46	1489	9.31	-	-	-	-
9990	2700	1130	4.00	1198	4.82	1259	5.63	1315	6.45	1369	7.28	1420	8.13	1469	8.99	1517	9.87	-	-	-	-
10360	2800	1166	4.40	1233	5.24	1293	6.09	1348	6.94	1400	7.80	1450	8.67	1499	9.55	-	-	-	-	-	-
10545	2850	1185	4.60	1251	5.47	1310	6.33	1365	7.19	1416	8.06	1466	8.95	1513	9.85	-	-	-	-	-	-
10730	2900	1203	4.82	1268	5.70	1327	6.57	1381	7.45	1432	8.33	1481	9.23	-	-	-	-	-	-	-	-
10915	2950	1221	5.04	1286	5.94	1344	6.83	1398	7.72	1448	8.62	1497	9.53	-	-	-	-	-	-	-	-
11100	3000	1240	5.27	1304	6.18	1361	7.09	1414	7.99	1465	8.91	1513	9.83	-	-	-	-	-	-	-	-
11470	3100	1276	5.75	1339	6.70	1396	7.63	1448	8.56	1497	9.50	-	-	-	-	-	-	-	-	-	-
11840	3200	1313	6.26	1375	7.24	1430	8.20	1482	9.17	-	-	-	-	-	-	-	-	-	-	-	-
12025	3250	1332	6.53	1393	7.52	1448	8.50	1499	9.48	-	-	-	-	-	-	-	-	-	-	-	-
12210	3300	1350	6.80	1411	7.81	1465	8.81	1516	9.80	-	-	-	-	-	-	-	-	-	-	-	-
12395	3350	1369	7.08	1429	8.11	1483	9.12	-	-	-	-	-	-	-	-	-	-	-	-	-	-
12580	3400	1387	7.37	1447	8.42	1500	9.44	-	-	-	-	-	-	-	-	-	-	-	-	-	-
12765	3450	1406	7.67	1465	8.73	1518	9.77	-	-	-	-	-	-	-	-	-	-	-	-	-	-
12950	3500	1424	7.98	1483	9.05	-	-	-	-	-	-	-	-	-	-	-	-	-	-	-	-
13320	3600	1462	8.62	1519	9.73	-	-	-	-	-	-	-	-	-	-	-	-	-	-	-	-
13505	3650	1480	8.95	-	-	-	-	-	-	-	-	-	-	-	-	-	-	-	-	-	-

Performance certified is for installation type B - free inlet, ducted outlet.
 Performance ratings do not include the effects of appurtenances (accessories).
 Power rating (BHP) does not include transmission losses.



Soler & Palau USA, Div. of Soler & Palau Ventilation Group certifies that the Models CM shown herein are licensed to bear the AMCA Seal (except CM10). The ratings shown are based on test and procedures performed in accordance with AMCA Publication 211 and AMCA Publication 311 and comply with the requirement of the AMCA Certified Ratings Program.



UL STANDARD 705
 UL STANDARD 762
 UL STANDARD 793

Optional - Must be specified

CM 27

Wheel Diameter: 28-1/4"
Outlet Area: 4.70 Sq. Ft.
Average Weight: CM - 549 lbs
Shaft Diameter: 1-3/4"
Tip Speed: 7.40 x RPM=FPM
Max Fan RPM: 1,297 RPM
Max Motor HP: CM - 15 HP

CFM	OV	Static Pressure (Inches W.G.)																			
		0.5		1		1.5		2		2.5		3		3.5		4		4.5		5	
		RPM	BHP	RPM	BHP	RPM	BHP	RPM	BHP	RPM	BHP	RPM	BHP	RPM	BHP	RPM	BHP	RPM	BHP	RPM	BHP
3760	800	448	0.43	568	0.81	672	1.2	-	-	-	-	-	-	-	-	-	-	-	-	-	-
4230	900	472	0.51	585	0.92	684	1.4	-	-	-	-	-	-	-	-	-	-	-	-	-	-
4700	1000	497	0.60	605	1.04	699	1.5	785	2.0	-	-	-	-	-	-	-	-	-	-	-	-
5170	1100	524	0.71	626	1.18	716	1.7	799	2.2	875	2.8	-	-	-	-	-	-	-	-	-	-
5405	1150	538	0.77	638	1.25	726	1.8	807	2.3	882	2.9	952	3.5	-	-	-	-	-	-	-	-
5640	1200	552	0.83	649	1.33	736	1.9	815	2.4	889	3.0	958	3.7	-	-	-	-	-	-	-	-
5875	1250	567	0.90	661	1.41	746	2.0	824	2.6	896	3.2	965	3.8	1029	4.5	-	-	-	-	-	-
6110	1300	581	0.97	674	1.49	757	2.1	833	2.7	904	3.3	971	4.0	1035	4.6	1097	5.4	-	-	-	-
6345	1350	596	1.04	687	1.58	768	2.2	842	2.8	912	3.4	979	4.1	1042	4.8	1102	5.5	-	-	-	-
6580	1400	611	1.12	700	1.68	779	2.3	852	2.9	921	3.6	986	4.3	1049	5.0	1108	5.7	1165	6.5	-	-
6815	1450	626	1.20	713	1.78	791	2.4	863	3.0	930	3.7	995	4.4	1056	5.1	1115	5.9	1171	6.7	-	-
7050	1500	641	1.29	726	1.88	803	2.5	873	3.2	940	3.9	1003	4.6	1064	5.3	1122	6.1	1177	6.9	1231	7.7
7520	1600	672	1.48	754	2.11	827	2.8	896	3.5	960	4.2	1021	4.9	1080	5.7	1136	6.5	1191	7.3	1243	8.1
7755	1650	688	1.59	768	2.23	840	2.9	907	3.6	971	4.3	1031	5.1	1089	5.9	1144	6.7	1198	7.5	1250	8.4
7990	1700	703	1.70	782	2.35	853	3.0	919	3.8	981	4.5	1041	5.3	1098	6.1	1153	6.9	1206	7.8	1257	8.6
8460	1800	735	1.93	811	2.62	879	3.3	943	4.1	1004	4.9	1062	5.7	1117	6.5	1171	7.4	1222	8.2	1272	9.1
8695	1850	751	2.06	825	2.76	893	3.5	956	4.3	1015	5.1	1072	5.9	1127	6.7	1180	7.6	1231	8.5	1280	9.4
8930	1900	767	2.19	840	2.91	907	3.7	969	4.4	1027	5.3	1083	6.1	1137	6.9	1189	7.8	1240	8.7	1289	9.7
9165	1950	783	2.33	855	3.07	920	3.8	981	4.6	1039	5.5	1095	6.3	1148	7.2	1199	8.1	1249	9.0	1297	9.9
9400	2000	799	2.48	870	3.23	934	4.0	995	4.8	1052	5.7	1106	6.5	1159	7.4	1209	8.3	1259	9.3	1306	10.2
9635	2050	815	2.63	885	3.40	948	4.2	1008	5.0	1064	5.9	1118	6.8	1170	7.7	1220	8.6	1268	9.5	1316	10.5
9870	2100	832	2.79	900	3.58	963	4.4	1021	5.2	1077	6.1	1130	7.0	1181	7.9	1230	8.9	1278	9.8	1325	10.8
10105	2150	848	2.95	916	3.76	977	4.6	1035	5.5	1089	6.3	1142	7.2	1192	8.2	1241	9.1	1289	10.1	1335	11.1
10340	2200	865	3.13	931	3.95	992	4.8	1048	5.7	1102	6.6	1154	7.5	1204	8.4	1252	9.4	1299	10.4	1345	11.4
10575	2250	881	3.31	946	4.15	1006	5.0	1062	5.9	1116	6.8	1167	7.8	1216	8.7	1264	9.7	1310	10.7	1355	11.7
10810	2300	897	3.49	962	4.35	1021	5.2	1076	6.1	1129	7.1	1179	8.0	1228	9.0	1275	10.0	1321	11.0	1365	12.1
11280	2400	931	3.89	993	4.78	1051	5.7	1105	6.6	1156	7.6	1205	8.6	1253	9.6	1299	10.6	1343	11.7	1387	12.7
11750	2500	964	4.32	1025	5.25	1081	6.2	1133	7.2	1183	8.2	1231	9.2	1278	10.2	1323	11.3	1367	12.3	1409	13.4
11985	2550	981	4.55	1041	5.49	1096	6.5	1148	7.4	1197	8.5	1245	9.5	1291	10.5	1335	11.6	1378	12.7	1421	13.8
12220	2600	998	4.78	1057	5.74	1111	6.7	1162	7.7	1211	8.8	1258	9.8	1304	10.9	1348	12.0	1390	13.1	1432	14.2
12455	2650	1014	5.03	1073	6.00	1126	7.0	1177	8.0	1225	9.1	1272	10.1	1317	11.2	1360	12.3	1403	13.4	-	-
12690	2700	1031	5.28	1089	6.27	1142	7.3	1192	8.3	1240	9.4	1286	10.5	1330	11.6	1373	12.7	1415	13.8	-	-
12925	2750	1048	5.54	1105	6.55	1157	7.6	1207	8.6	1254	9.7	1299	10.8	1343	11.9	1386	13.0	1427	14.2	-	-
13160	2800	1065	5.81	1121	6.84	1173	7.9	1222	9.0	1268	10.0	1313	11.2	1357	12.3	1399	13.4	1440	14.6	-	-
13630	2900	1099	6.38	1153	7.44	1204	8.5	1252	9.6	1298	10.7	1342	11.9	1384	13.0	1425	14.2	-	-	-	-
14100	3000	1133	6.98	1186	8.08	1236	9.2	1282	10.3	1327	11.5	1370	12.7	1412	13.9	1452	15.1	-	-	-	-
14335	3050	1150	7.30	1202	8.42	1251	9.6	1298	10.7	1342	11.9	1385	13.1	1426	14.3	-	-	-	-	-	-
14570	3100	1167	7.63	1219	8.76	1267	9.9	1313	11.1	1357	12.3	1399	13.5	1440	14.7	-	-	-	-	-	-
14805	3150	1184	7.96	1235	9.12	1283	10.3	1328	11.5	1372	12.7	1414	13.9	1454	15.1	-	-	-	-	-	-
15040	3200	1201	8.31	1252	9.48	1299	10.7	1344	11.9	1387	13.1	1428	14.3	-	-	-	-	-	-	-	-
15275	3250	1218	8.67	1268	9.86	1315	11.1	1359	12.3	1402	13.5	1443	14.8	-	-	-	-	-	-	-	-
15510	3300	1236	9.04	1285	10.25	1331	11.5	1375	12.7	1417	14.0	-	-	-	-	-	-	-	-	-	-
15745	3350	1253	9.42	1302	10.65	1347	11.9	1391	13.1	1432	14.4	-	-	-	-	-	-	-	-	-	-
15980	3400	1270	9.81	1318	11.05	1363	12.3	1406	13.6	1448	14.9	-	-	-	-	-	-	-	-	-	-

Performance certified is for installation type B - free inlet, ducted outlet.
 Performance ratings do not include the effects of appurtenances (accessories).
 Power rating (BHP) does not include transmission losses.
Bold Performance points are available on CM units ONLY.



Soler & Palau USA, Div. of Soler & Palau Ventilation Group certifies that the Models CM shown herein are licensed to bear the AMCA Seal (except CM10). The ratings shown are based on test and procedures performed in accordance with AMCA Publication 211 and AMCA Publication 311 and comply with the requirement of the AMCA Certified Ratings Program.



UL STANDARD 705
UL STANDARD 762
UL STANDARD 793
 Optional - Must be specified

CM 30

Wheel Diameter: 31-7/8"
Outlet Area: 5.76 Sq. Ft.
Average Weight: CM - 739 lbs
Shaft Diameter: 1-3/4"
Tip Speed: 8.33 x RPM=FPM
Max Fan RPM: 1,093 RPM
Max Motor HP: CM - 15 HP

CFM	OV	Static Pressure (Inches W.G.)																			
		0.5		1		1.5		2		2.5		3		3.5		4		4.5		5	
		RPM	BHP	RPM	BHP	RPM	BHP	RPM	BHP	RPM	BHP	RPM	BHP	RPM	BHP	RPM	BHP	RPM	BHP	RPM	BHP
4608	800	394	0.5	502	1.0	-	-	-	-	-	-	-	-	-	-	-	-	-	-	-	-
5184	900	415	0.6	516	1.1	604	1.7	-	-	-	-	-	-	-	-	-	-	-	-	-	-
5760	1000	437	0.8	533	1.3	617	1.9	693	2.5	-	-	-	-	-	-	-	-	-	-	-	-
6048	1050	448	0.8	542	1.4	624	2.0	699	2.6	768	3.3	-	-	-	-	-	-	-	-	-	-
6336	1100	460	0.9	551	1.5	632	2.1	705	2.8	773	3.5	-	-	-	-	-	-	-	-	-	-
6624	1150	472	1.0	561	1.6	640	2.2	712	2.9	779	3.6	842	4.4	-	-	-	-	-	-	-	-
6912	1200	484	1.0	571	1.7	648	2.3	719	3.0	785	3.8	847	4.5	-	-	-	-	-	-	-	-
7200	1250	496	1.1	581	1.8	657	2.4	726	3.2	791	3.9	852	4.7	910	5.5	-	-	-	-	-	-
7488	1300	509	1.2	592	1.9	666	2.6	734	3.3	798	4.1	858	4.9	915	5.7	-	-	-	-	-	-
7776	1350	521	1.3	603	2.0	676	2.7	742	3.5	805	4.3	864	5.1	920	5.9	974	6.8	-	-	-	-
8064	1400	534	1.4	614	2.1	685	2.8	751	3.6	813	4.4	871	5.3	926	6.2	979	7.1	1030	8.0	-	-
8352	1450	547	1.5	625	2.2	695	3.0	760	3.8	820	4.6	878	5.5	932	6.4	985	7.3	1035	8.2	-	-
8640	1500	560	1.6	637	2.3	706	3.1	769	3.9	829	4.8	885	5.7	939	6.6	990	7.5	1040	8.5	1088	9.5
8928	1550	573	1.7	649	2.5	716	3.3	778	4.1	837	5.0	893	5.9	946	6.8	997	7.8	1046	8.8	1093	9.8
9216	1600	587	1.8	661	2.6	727	3.4	788	4.3	846	5.2	901	6.1	953	7.1	1003	8.0	1052	9.0	1098	10.1
9504	1650	600	2.0	673	2.8	738	3.6	798	4.5	855	5.4	909	6.3	960	7.3	1010	8.3	1058	9.3	1104	10.4
9792	1700	613	2.1	685	2.9	749	3.8	808	4.7	864	5.6	917	6.6	968	7.6	1017	8.6	1064	9.6	1110	10.7
10080	1750	627	2.2	697	3.1	760	4.0	819	4.9	874	5.8	926	6.8	976	7.8	1025	8.8	1071	9.9	1116	11.0
10368	1800	641	2.4	710	3.3	772	4.2	829	5.1	883	6.1	935	7.1	985	8.1	1032	9.1	1078	10.2	1123	11.3
10656	1850	654	2.5	722	3.4	783	4.4	840	5.3	893	6.3	944	7.3	993	8.4	1040	9.4	1086	10.5	1130	11.6
10944	1900	668	2.7	735	3.6	795	4.6	851	5.5	903	6.5	954	7.6	1002	8.6	1048	9.7	1093	10.8	1137	12.0
11232	1950	682	2.9	748	3.8	807	4.8	862	5.8	914	6.8	963	7.8	1011	8.9	1057	10.0	1101	11.2	1144	12.3
11520	2000	696	3.1	761	4.0	819	5.0	873	6.0	924	7.0	973	8.1	1020	9.2	1066	10.3	1109	11.5	1152	12.7
11808	2050	710	3.2	773	4.2	831	5.2	884	6.3	935	7.3	983	8.4	1030	9.5	1074	10.7	1118	11.8	1160	13.0
12096	2100	724	3.4	787	4.4	843	5.5	896	6.5	946	7.6	993	8.7	1039	9.8	1084	11.0	1126	12.2	1168	13.4
12384	2150	738	3.6	800	4.7	855	5.7	908	6.8	957	7.9	1004	9.0	1049	10.2	1093	11.3	1135	12.6	1176	13.8
12672	2200	752	3.9	813	4.9	868	6.0	919	7.0	968	8.2	1014	9.3	1059	10.5	1102	11.7	1144	12.9	1185	14.2
13248	2300	780	4.3	839	5.4	893	6.5	943	7.6	991	8.8	1036	10.0	1080	11.2	1122	12.4	1163	13.7	1203	15.0
13536	2350	795	4.5	853	5.6	906	6.8	955	7.9	1002	9.1	1047	10.3	1090	11.5	1132	12.8	1172	14.1	-	-
13824	2400	809	4.8	866	5.9	919	7.1	967	8.2	1014	9.4	1058	10.7	1101	11.9	1142	13.2	1182	14.5	-	-
14112	2450	823	5.1	880	6.2	932	7.4	980	8.6	1026	9.8	1069	11.0	1112	12.3	1152	13.6	1192	14.9	-	-
14400	2500	838	5.3	894	6.5	944	7.7	992	8.9	1037	10.1	1081	11.4	1122	12.7	1163	14.0	-	-	-	-
14688	2550	852	5.6	907	6.8	958	8.0	1005	9.2	1049	10.5	1092	11.8	1133	13.1	1173	14.4	-	-	-	-
14976	2600	866	5.9	921	7.1	971	8.3	1017	9.6	1061	10.9	1104	12.2	1145	13.5	1184	14.9	-	-	-	-
15552	2700	895	6.5	948	7.7	997	9.0	1043	10.3	1086	11.6	1127	13.0	1167	14.4	-	-	-	-	-	-
15840	2750	910	6.8	962	8.1	1010	9.4	1055	10.7	1098	12.0	1139	13.4	1179	14.8	-	-	-	-	-	-
16128	2800	924	7.1	976	8.4	1024	9.8	1068	11.1	1110	12.5	1151	13.9	-	-	-	-	-	-	-	-
16416	2850	939	7.5	990	8.8	1037	10.1	1081	11.5	1123	12.9	1163	14.3	-	-	-	-	-	-	-	-
16704	2900	954	7.8	1004	9.2	1050	10.5	1094	11.9	1136	13.3	1175	14.8	-	-	-	-	-	-	-	-
16992	2950	968	8.2	1018	9.6	1064	11.0	1107	12.4	1148	13.8	-	-	-	-	-	-	-	-	-	-
17280	3000	983	8.6	1032	10.0	1077	11.4	1120	12.8	1161	14.2	-	-	-	-	-	-	-	-	-	-
17568	3050	998	9.0	1046	10.4	1091	11.8	1133	13.2	1174	14.7	-	-	-	-	-	-	-	-	-	-
17856	3100	1012	9.4	1060	10.8	1105	12.2	1147	13.7	-	-	-	-	-	-	-	-	-	-	-	-
18144	3150	1027	9.8	1074	11.2	1118	12.7	1160	14.2	-	-	-	-	-	-	-	-	-	-	-	-

Performance certified is for installation type B - free inlet, ducted outlet.
 Performance ratings do not include the effects of appurtenances (accessories).
 Power rating (BHP) does not include transmission losses.



Soler & Palau USA, Div. of Soler & Palau Ventilation Group certifies that the Models CM shown herein are licensed to bear the AMCA Seal (except CM10). The ratings shown are based on test and procedures performed in accordance with AMCA Publication 211 and AMCA Publication 311 and comply with the requirement of the AMCA Certified Ratings Program.



UL STANDARD 705
 UL STANDARD 762
 UL STANDARD 793

Optional - Must be specified



CM 36

Wheel Diameter: 35-5/8"
Outlet Area: 7.26 Sq. Ft.
Inlet Area: 6.945 Sq. Ft.
Average Weight: 959 lb
Shaft Diameter: 2-3/16"
Tip Speed: 9.33 x RPM=FPM
Max Fan RPM: 1,061 RPM
Max Motor HP: 15 HP

CFM	OV	Static Pressure (Inches W.G.)																			
		0.5		1		1.5		2		2.5		3		3.5		4		4.5		5	
		RPM	BHP	RPM	BHP	RPM	BHP	RPM	BHP	RPM	BHP	RPM	BHP	RPM	BHP	RPM	BHP	RPM	BHP	RPM	BHP
5808	800	352	0.68	448	1.27	531	1.93	-	-	-	-	-	-	-	-	-	-	-	-	-	-
6534	900	371	0.80	461	1.44	540	2.14	-	-	-	-	-	-	-	-	-	-	-	-	-	-
7260	1000	391	0.94	476	1.63	551	2.38	619	3.18	-	-	-	-	-	-	-	-	-	-	-	-
7623	1050	401	1.02	484	1.73	558	2.50	624	3.33	686	4.20	-	-	-	-	-	-	-	-	-	-
7986	1100	412	1.11	493	1.84	564	2.64	630	3.49	691	4.38	-	-	-	-	-	-	-	-	-	-
8349	1150	422	1.20	501	1.95	572	2.77	636	3.65	696	4.57	752	5.52	-	-	-	-	-	-	-	-
8712	1200	433	1.29	510	2.07	579	2.92	642	3.81	701	4.76	756	5.74	-	-	-	-	-	-	-	-
9075	1250	445	1.40	520	2.20	587	3.07	649	3.99	707	4.95	761	5.96	813	7.00	-	-	-	-	-	-
9438	1300	456	1.51	529	2.33	595	3.22	656	4.17	713	5.15	766	6.18	817	7.25	866	8.35	-	-	-	-
9801	1350	467	1.62	539	2.47	604	3.39	663	4.35	719	5.36	772	6.42	822	7.51	870	8.63	916	9.8	-	-
10164	1400	479	1.74	549	2.62	613	3.56	671	4.55	726	5.58	778	6.66	827	7.77	875	8.92	920	10.1	-	-
10527	1450	491	1.87	560	2.78	622	3.74	679	4.75	733	5.81	784	6.91	833	8.04	880	9.21	925	10.4	968	11.6
10890	1500	503	2.01	570	2.94	631	3.92	687	4.96	740	6.04	790	7.16	839	8.32	885	9.51	929	10.7	972	12.0
11253	1550	515	2.16	581	3.11	640	4.12	696	5.17	748	6.28	797	7.42	845	8.61	890	9.82	934	11.1	977	12.4
11616	1600	527	2.31	592	3.29	650	4.32	704	5.40	756	6.53	804	7.70	851	8.90	896	10.1	939	11.4	981	12.7
12342	1700	551	2.65	613	3.67	670	4.75	722	5.88	772	7.05	819	8.27	865	9.52	909	10.8	951	12.1	992	13.5
12705	1750	563	2.83	625	3.87	680	4.98	732	6.13	781	7.33	827	8.56	872	9.84	915	11.2	957	12.5	997	13.9
13068	1800	576	3.01	636	4.09	690	5.21	741	6.39	789	7.61	835	8.87	880	10.2	922	11.5	963	12.9	1003	14.3
13431	1850	588	3.21	647	4.31	701	5.46	751	6.66	798	7.91	844	9.19	887	10.5	929	11.9	970	13.3	1009	14.7
13794	1900	601	3.42	659	4.54	712	5.72	761	6.94	808	8.21	852	9.52	895	10.9	937	12.2	977	13.7	1016	15.1
14157	1950	613	3.64	670	4.78	722	5.98	771	7.23	817	8.52	861	9.9	903	11.2	944	12.6	984	14.1	-	-
14520	2000	626	3.86	682	5.04	733	6.26	781	7.53	826	8.85	870	10.2	912	11.6	952	13.0	991	14.5	-	-
15246	2100	651	4.35	706	5.57	755	6.85	802	8.17	846	9.53	888	10.9	929	12.4	968	13.8	-	-	-	-
15609	2150	664	4.61	718	5.86	767	7.16	812	8.50	856	9.89	898	11.3	938	12.8	977	14.3	-	-	-	-
15972	2200	677	4.88	730	6.15	778	7.48	823	8.85	866	10.3	907	11.7	947	13.2	985	14.7	-	-	-	-
16335	2250	690	5.16	742	6.46	789	7.81	834	9.20	876	10.6	917	12.1	956	13.6	-	-	-	-	-	-
16698	2300	702	5.45	754	6.78	801	8.15	845	9.57	886	11.0	927	12.5	965	14.1	-	-	-	-	-	-
17061	2350	715	5.76	766	7.11	812	8.51	856	10.0	897	11.4	937	13.0	975	14.5	-	-	-	-	-	-
17424	2400	728	6.07	778	7.45	824	8.88	867	10.3	907	11.9	947	13.4	984	15.0	-	-	-	-	-	-
18150	2500	754	6.74	803	8.18	847	9.65	889	11.2	929	12.7	967	14.3	-	-	-	-	-	-	-	-
18513	2550	767	7.10	815	8.56	859	10.1	900	11.6	940	13.2	977	14.8	-	-	-	-	-	-	-	-
18876	2600	781	7.47	828	8.95	871	10.5	912	12.0	951	13.6	-	-	-	-	-	-	-	-	-	-
19239	2650	794	7.85	840	9.36	883	10.9	923	12.5	962	14.1	-	-	-	-	-	-	-	-	-	-
19602	2700	807	8.24	853	9.8	895	11.4	935	13.0	973	14.6	-	-	-	-	-	-	-	-	-	-
19965	2750	820	8.65	865	10.2	907	11.8	946	13.5	984	15.1	-	-	-	-	-	-	-	-	-	-
20328	2800	833	9.1	878	10.7	919	12.3	958	14.0	-	-	-	-	-	-	-	-	-	-	-	-
21054	2900	860	10.0	903	11.6	943	13.3	981	15.0	-	-	-	-	-	-	-	-	-	-	-	-
21417	2950	873	10.4	916	12.1	956	13.8	-	-	-	-	-	-	-	-	-	-	-	-	-	-
21780	3000	886	10.9	929	12.6	968	14.3	-	-	-	-	-	-	-	-	-	-	-	-	-	-
22143	3050	900	11.4	941	13.1	980	14.9	-	-	-	-	-	-	-	-	-	-	-	-	-	-
22506	3100	913	11.9	954	13.7	-	-	-	-	-	-	-	-	-	-	-	-	-	-	-	-
22869	3150	926	12.5	967	14.2	-	-	-	-	-	-	-	-	-	-	-	-	-	-	-	-
23232	3200	940	13.0	980	14.8	-	-	-	-	-	-	-	-	-	-	-	-	-	-	-	-
23958	3300	966	14.1	-	-	-	-	-	-	-	-	-	-	-	-	-	-	-	-	-	-

Performance certified is for installation type B - free inlet, ducted outlet. Performance ratings do not include the effects of appurtenances (accessories). Power rating (BHP) does not include transmission losses.



Soler & Palau USA, Div. of Soler & Palau Ventilation Group certifies that the Models CM shown herein are licensed to bear the AMCA Seal (except CM10). The ratings shown are based on test and procedures performed in accordance with AMCA Publication 211 and AMCA Publication 311 and comply with the requirement of the AMCA Certified Ratings Program.



UL STANDARD 705
UL STANDARD 762
UL STANDARD 793

Optional - Must be specified

SOUND CHARACTERISTICS

CM 10

RPM	Sound Performance Sones / LwA (Inches w.g.)						
	0.5	1	1.5	2	2.5	3	3.5
1325	4.4 / 60.1	-	-	-	-	-	-
1500	5.7 / 64.2	-	-	-	-	-	-
1700	7.5 / 68.6	6.6 / 65.9	-	-	-	-	-
1875	9.5 / 72.1	8.2 / 69.5	-	-	-	-	-
2050	11.7 / 75.4	9.9 / 72.6	9.3 / 70.9	-	-	-	-
2250	14.4 / 78.7	12.2 / 76.0	11.4 / 74.6	11.1 / 73.2	-	-	-
2450	17.0 / 81.5	14.5 / 78.9	13.5 / 77.5	13.1 / 76.6	-	-	-
2625	19.1 / 83.5	17.1 / 81.5	15.7 / 80.0	15.0 / 79.1	14.6 / 78.1	-	-
2825	21 / 85.2	19.6 / 84.0	17.9 / 82.3	17.1 / 81.3	16.6 / 80.6	16.3 / 79.7	-
3000	23 / 86.7	22 / 85.9	19.8 / 84.1	19.0 / 83.2	18.4 / 82.5	18.1 / 81.8	18.1 / 81.2

CM 12

RPM	Sound Performance Sones / LwA (Inches w.g.)									
	0.5	1	1.5	2	2.5	3	3.5	4	4.5	5
1025	4.7 / 60.7	-	-	-	-	-	-	-	-	-
1225	7.1 / 67.4	-	-	-	-	-	-	-	-	-
1450	10.2 / 73.3	8.8 / 70.4	-	-	-	-	-	-	-	-
1650	13.7 / 77.9	11.5 / 75.1	10.7 / 73.3	-	-	-	-	-	-	-
1850	17.6 / 81.9	14.8 / 79.2	13.7 / 77.5	13.1 / 76.3	-	-	-	-	-	-
2050	21 / 84.9	18.6 / 82.8	17.2 / 81.3	16.3 / 80.1	15.9 / 79.2	-	-	-	-	-
2275	25 / 88.0	24 / 86.8	21 / 85	20 / 84	19.6 / 83.1	19.3 / 82.4	-	-	-	-
2475	30 / 90.5	28 / 89.9	26 / 88.1	24 / 87.1	23 / 86.3	23 / 85.5	23 / 85	-	-	-
2700	34 / 92.8	34 / 92.6	31 / 91.3	29 / 90.0	28 / 89.3	27 / 88.6	26 / 87.9	26 / 87.5	26 / 87.2	-
2900	38 / 94.5	38 / 94.3	36 / 93.6	33 / 92.3	32 / 91.4	31 / 90.9	30 / 90.3	29 / 89.7	29 / 89.3	29 / 89.1

CM 14

RPM	Sound Performance Sones / LwA (Inches w.g.)									
	0.5	1	1.5	2	2.5	3	3.5	4	4.5	5
900	4.8 / 60.6	-	-	-	-	-	-	-	-	-
1100	7.7 / 68.7	-	-	-	-	-	-	-	-	-
1300	10.8 / 74.4	9.4 / 71.7	-	-	-	-	-	-	-	-
1500	14.4 / 79.0	12.5 / 76.8	11.3 / 74.8	-	-	-	-	-	-	-
1700	18.4 / 82.9	16.5 / 81.2	15.0 / 79.7	13.9 / 78.2	-	-	-	-	-	-
1900	23 / 86.3	21 / 85.1	19.3 / 83.9	18.0 / 82.8	17.0 / 81.7	15.5 / 79.4	-	-	-	-
2100	27 / 89.4	25 / 88.4	24 / 87.5	23 / 86.7	22 / 85.9	21 / 85.2	19.4 / 83.9	-	-	-
2300	32 / 92.2	30 / 91.3	29 / 90.6	28 / 90.1	26 / 89.4	25 / 88.8	25 / 88.4	23 / 87.5	-	-
2500	37 / 94.2	35 / 93.5	33 / 92.9	32 / 92.4	31 / 91.8	30 / 91.2	29 / 90.7	28 / 90.3	27 / 89.7	26 / 88.7
2700	41 / 96.2	40 / 95.6	38 / 95.0	37 / 94.5	36 / 94.1	34 / 93.6	33 / 93.1	32 / 92.6	31 / 92.2	31 / 91.8

The A-weighted sound ratings shown have been calculated per AMCA standard 301. Values shown are for inlet Lwi(A) sound power levels for installation type B - free inlet, ducted outlet. Ratings do not include the effect of duct end corrections.



Soler & Palau USA, Div. of Soler & Palau Ventilation Group certifies that the Models CM shown herein are licensed to bear the AMCA Seal (except CM10). The ratings shown are based on test and procedures performed in accordance with AMCA Publication 211 and AMCA Publication 311 and comply with the requirement of the AMCA Certified Ratings Program.

CM 16

RPM	Sound Performance Sones / LwA (Inches w.g.)									
	0.5	1	1.5	2	2.5	3	3.5	4	4.5	5
800	5.0 / 61.1	-	-	-	-	-	-	-	-	-
1000	8.6 / 70.3	-	-	-	-	-	-	-	-	-
1150	11.6 / 75.3	9.4 / 71.6	-	-	-	-	-	-	-	-
1300	15.2 / 79.7	12.4 / 76.4	10.7 / 73.7	-	-	-	-	-	-	-
1450	19.3 / 83.5	16.1 / 80.7	14.2 / 78.5	12.4 / 75.9	-	-	-	-	-	-
1625	24 / 87.0	21 / 85.0	18.6 / 83.0	17.1 / 81.5	15.3 / 79.3	-	-	-	-	-
1800	29 / 90.1	27 / 88.9	24 / 87.1	22 / 85.5	20 / 84.4	18.5 / 82.6	-	-	-	-
1950	34 / 92.6	32 / 92.0	29 / 90.1	26 / 88.8	25 / 87.6	23 / 86.7	21 / 85.1	20.0 / 83.4	-	-
2150	39 / 95.1	39 / 94.8	35 / 93.5	32 / 92.2	30 / 91.1	28 / 90.1	27 / 89.4	26 / 88.4	24 / 86.8	23 / 85.5
2300	44 / 96.7	43 / 96.5	40 / 95.7	37 / 94.4	35 / 93.4	33 / 92.4	31 / 91.6	30 / 91.0	29 / 90.2	27 / 88.8

CM 18

RPM	Sound Performance Sones / LwA (Inches w.g.)									
	0.5	1	1.5	2	2.5	3	3.5	4	4.5	5
700	4.8 / 60.4	-	-	-	-	-	-	-	-	-
875	8.4 / 69.5	-	-	-	-	-	-	-	-	-
1025	12.3 / 75.4	9.5 / 71.5	-	-	-	-	-	-	-	-
1175	17.0 / 80.3	13.9 / 77.4	11.3 / 74.2	-	-	-	-	-	-	-
1350	23 / 85.2	19.9 / 83.2	16.9 / 80.7	14.6 / 78	14.4 / 76.9	-	-	-	-	-
1500	27 / 88.0	24 / 86.6	22 / 84.7	19.0 / 82.7	16.9 / 80.5	16.5 / 79.3	-	-	-	-
1650	31 / 90.4	29 / 89.6	26 / 88.1	24 / 86.5	21 / 84.8	19.4 / 83	18.4 / 81.4	-	-	-
1825	35 / 93.1	34 / 92.6	32 / 91.5	29 / 90.3	27 / 89.0	25 / 87.6	23 / 86.1	21 / 84.6	22 / 84.3	-
2000	42 / 95.8	40 / 95.4	39 / 94.7	36 / 93.7	34 / 92.7	32 / 91.6	30 / 90.5	28 / 89.2	26 / 88.0	25 / 86.7
2150	48 / 98.0	47 / 97.7	46 / 97.3	43 / 96.5	41 / 95.6	38 / 94.7	36 / 93.7	34 / 92.7	32 / 91.6	30 / 90.5

CM 20

RPM	Sound Performance Sones / LwA (Inches w.g.)									
	0.5	1	1.5	2	2.5	3	3.5	4	4.5	5
650	5.6 / 62.7	-	-	-	-	-	-	-	-	-
775	8.4 / 69.7	-	-	-	-	-	-	-	-	-
900	12.0 / 75.3	9.3 / 71.1	-	-	-	-	-	-	-	-
1050	17.3 / 81	13.9 / 77.7	12.2 / 74.8	-	-	-	-	-	-	-
1175	22 / 85.0	18.4 / 82.1	16.5 / 80.2	14.9 / 77.8	-	-	-	-	-	-
1300	27 / 88.4	24 / 86.3	21 / 84.4	19.7 / 82.9	18.0 / 81	-	-	-	-	-
1450	33 / 91.5	31 / 90.2	27 / 88.3	25 / 87	24 / 85.9	22 / 84.6	20 / 82.6	-	-	-
1550	37 / 93.2	34 / 92.2	31 / 90.6	28 / 89.2	27 / 88.1	25 / 87.1	24 / 85.7	22 / 84.1	-	-
1700	42 / 95.6	40 / 94.8	37 / 93.6	34 / 92.3	32 / 91.3	30 / 90.4	29 / 89.4	28 / 88.5	26 / 86.9	-
1825	47 / 97.5	45 / 96.9	43 / 96.0	39 / 94.9	36 / 93.7	35 / 92.9	33 / 92.2	32 / 91.3	31 / 90.5	29 / 89.3

The A-weighted sound ratings shown have been calculated per AMCA standard 301. Values shown are for inlet Lwi(A) sound power levels for installation type B - free inlet, ducted outlet. Ratings do not include the effect of duct end corrections.



Soler & Palau USA, Div. of Soler & Palau Ventilation Group certifies that the Models CM shown herein are licensed to bear the AMCA Seal (except CM10). The ratings shown are based on test and procedures performed in accordance with AMCA Publication 211 and AMCA Publication 311 and comply with the requirement of the AMCA Certified Ratings Program.

CM 22

RPM	Sound Performance Sones / LwA (Inches w.g.)									
	0.5	1	1.5	2	2.5	3	3.5	4	4.5	5
575	5.7 / 62.7	-	-	-	-	-	-	-	-	-
700	9.0 / 70.3	-	-	-	-	-	-	-	-	-
825	13.1 / 76.4	10.6 / 72.9	-	-	-	-	-	-	-	-
950	18.1 / 81.5	14.9 / 78.4	13.4 / 76.1	-	-	-	-	-	-	-
1075	23 / 85.7	19.9 / 83.2	17.8 / 81.1	16.5 / 79.3	-	-	-	-	-	-
1225	30 / 89.7	27 / 88.2	24 / 86.4	22 / 84.9	21 / 83.3	19.8 / 82.1	-	-	-	-
1350	35 / 92.6	34 / 91.7	31 / 90.2	28 / 88.9	26 / 87.6	25 / 86.2	24 / 85.0	-	-	-
1475	40 / 94.8	39 / 94.4	36 / 93.2	34 / 91.9	32 / 90.9	30 / 89.8	28 / 88.7	27 / 87.7	26 / 86.9	-
1600	46 / 96.9	45 / 96.7	42 / 95.8	40 / 94.7	37 / 93.7	35 / 92.8	33 / 91.9	32 / 91.0	31 / 90.2	30 / 89.4
1725	51 / 98.9	50 / 98.7	49 / 98.2	46 / 97.3	43 / 96.4	41 / 95.6	39 / 94.8	37 / 94.0	36 / 93.3	35 / 92.6

CM 24

RPM	Sound Performance Sones / LwA (Inches w.g.)									
	0.5	1	1.5	2	2.5	3	3.5	4	4.5	5
500	5.2 / 61.9	-	-	-	-	-	-	-	-	-
625	9.5 / 71.7	-	-	-	-	-	-	-	-	-
725	13.4 / 77.1	10.2 / 72.8	-	-	-	-	-	-	-	-
825	17.6 / 81.4	14.3 / 78.4	12.1 / 75.2	-	-	-	-	-	-	-
950	23 / 85.9	20.0 / 84.0	17.4 / 81.4	15.5 / 79.2	-	-	-	-	-	-
1050	28 / 88.9	25 / 87.5	22 / 85.7	19.9 / 83.6	18.4 / 81.9	16.4 / 79.1	-	-	-	-
1175	34 / 92.1	32 / 91.4	29 / 90.1	26 / 88.5	24 / 86.8	23 / 85.5	20 / 83.2	-	-	-
1275	39 / 94.4	39 / 94.1	35 / 92.9	32 / 91.8	30 / 90.3	28 / 89.0	26 / 87.9	24 / 86.0	-	-
1400	45 / 96.8	45 / 96.5	42 / 95.8	39 / 94.9	36 / 93.9	34 / 92.7	32 / 91.5	30 / 90.6	29 / 89.7	26 / 87.6
1500	50 / 98.6	50 / 98.3	48 / 97.9	45 / 97.1	42 / 96.4	40 / 95.4	37 / 94.4	35 / 93.3	34 / 92.5	33 / 91.7

CM 27

RPM	Sound Performance Sones / LwA (Inches w.g.)									
	0.5	1	1.5	2	2.5	3	3.5	4	4.5	5
450	5.6 / 62.1	-	-	-	-	-	-	-	-	-
550	9.4 / 71.0	-	-	-	-	-	-	-	-	-
650	14.0 / 77.5	10.8 / 73.1	-	-	-	-	-	-	-	-
750	18.9 / 82.5	15.6 / 79.4	12.9 / 75.9	-	-	-	-	-	-	-
825	22 / 85.4	19.4 / 83.2	16.7 / 80.5	14.4 / 77.5	-	-	-	-	-	-
925	27 / 88.7	25 / 87.4	22 / 85.5	19.6 / 83.2	17.5 / 80.8	-	-	-	-	-
1025	32 / 91.6	31 / 91.0	28 / 89.5	25 / 87.9	23 / 86.0	21 / 83.9	19.8 / 82.5	-	-	-
1100	36 / 93.6	36 / 93.3	33 / 92.1	30 / 90.8	28 / 89.3	25 / 87.6	23 / 85.8	22 / 84.5	-	-
1200	42 / 96.1	42 / 95.8	40 / 95.2	37 / 94.2	34 / 93.1	32 / 91.8	29 / 90.3	27 / 88.7	26 / 87.5	-
1300	48 / 98.2	47 / 98.0	47 / 97.7	44 / 96.9	41 / 96.0	39 / 95.0	36 / 93.9	34 / 92.7	31 / 91.3	30 / 90.1

The A-weighted sound ratings shown have been calculated per AMCA standard 301. Values shown are for inlet Lwi(A) sound power levels for installation type B - free inlet, ducted outlet. Ratings do not include the effect of duct end corrections.



Soler & Palau USA, Div. of Soler & Palau Ventilation Group certifies that the Models CM shown herein are licensed to bear the AMCA Seal (except CM10). The ratings shown are based on test and procedures performed in accordance with AMCA Publication 211 and AMCA Publication 311 and comply with the requirement of the AMCA Certified Ratings Program.



CM 30

RPM	Sound Performance Sones / LwA (Inches w.g.)									
	0.5	1	1.5	2	2.5	3	3.5	4	4.5	5
400	5.6 / 62.2	-	-	-	-	-	-	-	-	-
475	8.8 / 69.9	-	-	-	-	-	-	-	-	-
550	12.7 / 75.7	9.5 / 70.8	-	-	-	-	-	-	-	-
625	16.8 / 80.4	13.3 / 76.5	11.1 / 73.1	-	-	-	-	-	-	-
700	21 / 84.2	17.6 / 81.3	14.9 / 78.3	13.5 / 76	-	-	-	-	-	-
775	26 / 87.5	22 / 85.3	19.4 / 82.8	17.2 / 80.5	16.3 / 78.9	-	-	-	-	-
875	32 / 91.2	29 / 89.8	26 / 87.9	23 / 86.0	21 / 84.1	20 / 82.8	-	-	-	-
950	38 / 93.7	35 / 92.7	32 / 91.1	29 / 89.5	26 / 87.8	24 / 86.3	23 / 85.2	-	-	-
1025	43 / 96.0	41 / 95.1	38 / 93.9	34 / 92.6	32 / 91.1	29 / 89.7	28 / 88.4	27 / 87.4	27 / 87.4	-
1100	49 / 97.9	46 / 97.1	44 / 96.2	40 / 95.1	37 / 93.9	35 / 92.7	32 / 91.4	31 / 90.3	29 / 89.3	29 / 89.0

CM 36

RPM	Sound Performance Sones / LwA (Inches w.g.)									
	0.5	1	1.5	2	2.5	3	3.5	4	4.5	5
350	5.6 / 61.6	-	-	-	-	-	-	-	-	-
425	9.1 / 69.9	-	-	-	-	-	-	-	-	-
500	13.7 / 76.6	10.4 / 72.0	-	-	-	-	-	-	-	-
575	19.8 / 82.1	16.0 / 78.3	13.1 / 75.0	-	-	-	-	-	-	-
650	26 / 86.4	22 / 83.4	19.3 / 81.1	16.8 / 78.3	-	-	-	-	-	-
725	32 / 89.8	28 / 87.7	25 / 85.5	22 / 83.5	20.0 / 81.3	-	-	-	-	-
800	37 / 92.6	34 / 91.2	30 / 89.1	28 / 87.6	25 / 85.9	23 / 84.0	23 / 83.1	-	-	-
875	43 / 95.2	40 / 94.2	37 / 92.5	33 / 90.9	31 / 89.7	29 / 88.2	26 / 86.6	26 / 85.4	-	-
950	49 / 97.6	47 / 96.7	44 / 95.6	40 / 94.1	37 / 93.0	35 / 91.9	33 / 90.7	30 / 89.3	30 / 88.2	30 / 87.7
1025	56 / 99.9	54 / 99.2	51 / 98.4	48 / 97.2	44 / 96.0	42 / 95.1	40 / 94.2	37 / 93.1	35 / 91.9	34 / 90.9

The A-weighted sound ratings shown have been calculated per AMCA standard 301. Values shown are for inlet Lwi(A) sound power levels for installation type B - free inlet, ducted outlet. Ratings do not include the effect of duct end corrections.



Soler & Palau USA, Div. of Soler & Palau Ventilation Group certifies that the Models CM shown herein are licensed to bear the AMCA Seal (except CM10). The ratings shown are based on test and procedures performed in accordance with AMCA Publication 211 and AMCA Publication 311 and comply with the requirement of the AMCA Certified Ratings Program.

Dimensional Data

MODEL CM

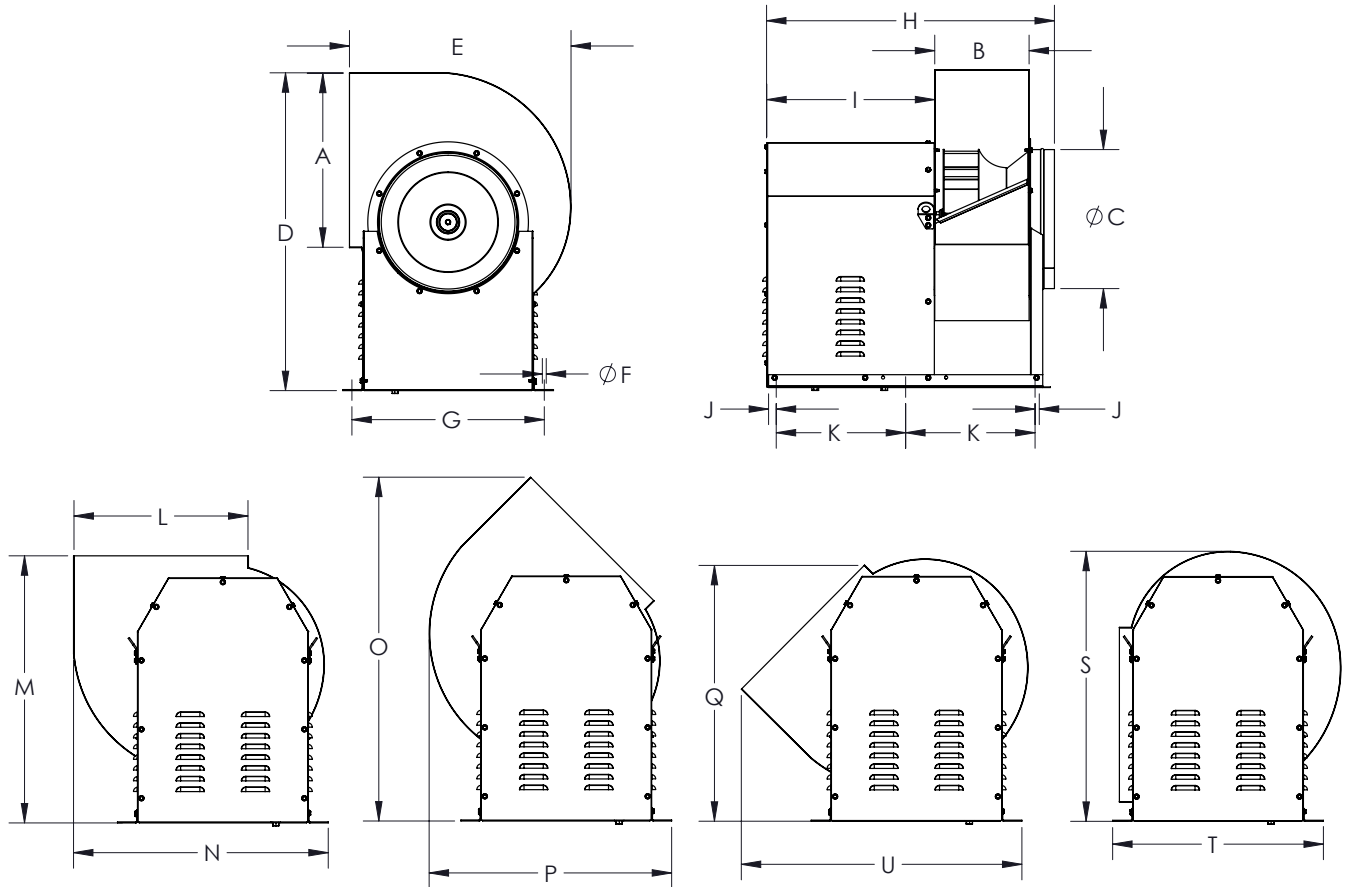

Model	A	B	C	D	E	F	G	H	I	J	K
10	12-3/4	7-1/8	9-7/8	23-7/8	17-1/4	1/2	16-7/8	25-3/8	15-1/2	1	10-7/8
12	16	8-3/4	12-3/8	29-1/8	21-3/8	1/2	19-5/8	28-3/4	17	1	12-1/2
14	18	10	14	32-3/4	22-3/4	1/2	19-5/8	30-3/4	17-7/8	1	13-1/4
16	20	10-3/4	15-3/4	36-3/4	25-1/4	1/2	21-7/8	31-5/8	18	1	13-7/8
18	22-1/2	12-1/8	17-3/4	40-7/8	28-1/2	1/2	24-3/4	37	21-5/8	1	16-5/8
20	25-1/4	13-5/8	19-3/4	44-7/8	31-1/4	1/2	27-1/2	38-3/8	21-5/8	1	17-1/2
22	28-1/4	15-1/4	22	49-3/8	35	1/2	29-7/8	40-1/8	21-5/8	1	18-1/4
24	31-5/8	17	24-3/4	55-1/2	39-1/8	1/2	33-1/4	41-7/8	21-5/8	1	19-1/8
27	35-1/2	18-7/8	28	66-7/8	44	1/2	35-1/4	50	27-1/4	4	20-1/4
30	39-3/4	21	31-1/2	74	49-1/4	1/2	39-3/8	53-3/4	28-3/4	2	24
36	44-3/4	23-3/8	35-1/2	82-1/2	55-1/4	1/2	45	59-1/8	32-1/2	2	27-1/8

Model	L	M	N	O	P	Q	S	T	U
10	12-3/4	21-5/8	20	25-7/8	19-3/8	21-5/8	20-3/8	18-7/8	22-7/8
12	16	26	24-1/4	32-1/2	23-1/8	24-3/4	24-7/8	21-7/8	27-1/2
14	18	28	25-7/8	35-5/8	24-5/8	27	28-1/4	23-1/4	29-3/8
16	20	31-1/8	29-1/4	39-7/8	27-5/8	29-7/8	31-3/8	26	32-1/4
18	22-1/2	34-3/8	32-3/4	44-1/8	38-1/4	33-3/4	34-3/4	29-1/4	36-7/8
20	25-1/4	37-1/2	36-1/8	48-3/8	34-1/4	37-1/8	38-1/8	32-3/8	40-1/2
22	28-1/4	41	40-1/8	53-1/4	37-3/4	40-3/4	42	35-3/4	45-3/8
24	31-5/8	45-7/8	44-5/8	59-3/4	42-1/8	45-1/2	47	39-7/8	50-3/4
27	35-1/2	55-5/8	50-5/8	71-1/2	46-1/8	54-7/8	57-1/4	44	57-1/2
30	39-3/4	62-3/8	57-1/8	80-1/8	51-1/4	62-1/2	63-1/4	49-1/4	61-1/4
36	44-3/4	70-1/2	64-3/8	89-3/4	57-1/2	70-5/8	70-5/8	55-1/4	72-3/8