

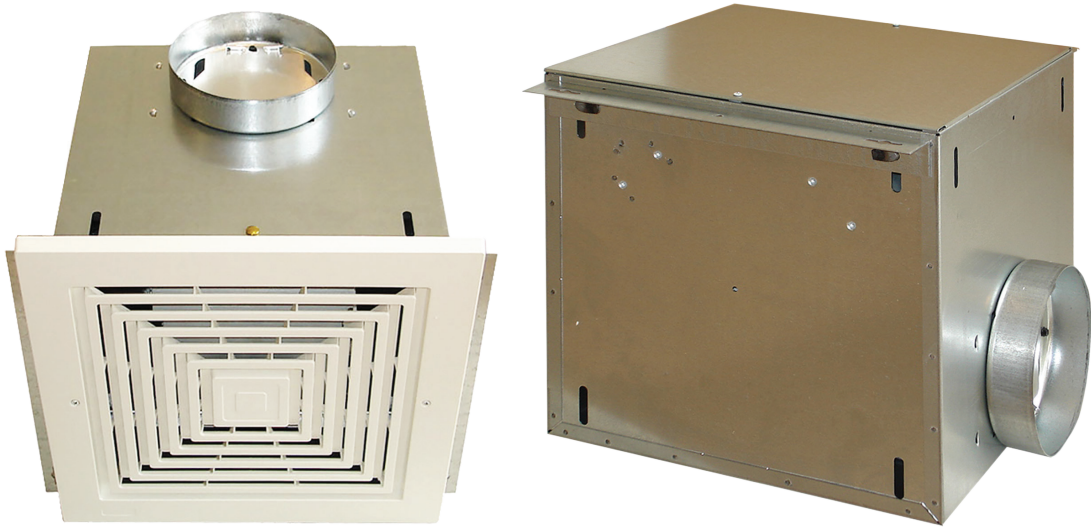

Losone Select Series



CEILING & INLINE/CABINET VENTILATORS

Advancing Ventilation®

Losone Select Series

CEILING & INLINE/CABINET VENTILATORS

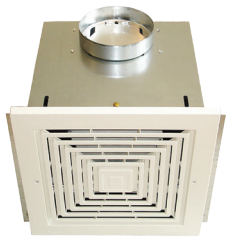

LOSONE SELECT CEILING MOUNT VENTILATOR FEATURES

- Exhaust air up to 701 CFM
- Forward curve centrifugal wheel for high static pressure capabilities to 1" w.g.
- Resilient mount, low RPM motor for quiet operation
- Speed controllable
- AMCA Seal for Air Performance
- cULus Listed

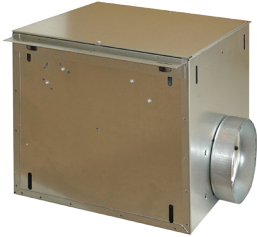

LOSONE SELECT INLINE/CABINET VENTILATOR FEATURES

- Exhaust air up to 681 CFM
- Forward curve centrifugal wheel for high static pressure capabilities to 1" w.g.
- Resilient mount, low RPM motor for quiet operation
- Speed controllable
- AMCA Seal for Air Performance
- cULus Listed

MODEL OVERVIEW

The extremely quiet Losone Select Series ventilators are available from 100 to 701 CFM, with static pressure capabilities to 1". All units have centrifugal blower wheels and low RPM motors on resilient mounts. The forward curved centrifugal wheel with its high static pressure capability makes these ventilators suitable for either ducted or nonducted applications. They include removable blower assemblies and plug-in permanently lubricated motors for ease of servicing and cleaning.

1 YEAR FAN HOUSING WARRANTY, 1 YEAR MOTOR WARRANTY



Losone Select Series

CEILING & INLINE/CABINET VENTILATORS



CONSTRUCTION/SPECIFICATION CHECKLIST

Grille

- Conceals interior.
- Low profile styling, blends with any decor.
- White polymeric (L100-L300).
- Metal finished with white enamel finish (L400-L700).

Blower

- Low RPM for quiet operation, speed controllable.
- Resilient anti-vibration mounts.
- Balanced, polymeric, centrifugal blower wheel for quiet, efficient performance. (Metal wheel on L2000L).
- Permanently lubricated, thermally protected motor.
- Plug-in motor.
- Designed for continuous operation.

Housing

- Rugged, 20 gauge galvanized steel.
- Duct connector.
- 1/2" acoustic insulation inside (except the Losone Select Inline/Cabinet Series).
- Integral automatic backdraft damper.
- May be installed in ceiling or wall.
- Mounting brackets for easy installation and adaptability to numerous mounting requirements.
- Factory-shipped in horizontal discharge position, easily converted to vertical discharge.
- Losone Select Inline Series units have a removable panel which allows for easy motor access without disturbing ductwork.

AMCA Seal

AMCA Air and Sound Licensed



UL Label

cULus listed



Losone Select Series

CEILING & INLINE/CABINET VENTILATORS



OPTIONS & ACCESSORIES

Roof Cap and Wall Cap

- Weather resistant duct termination.

Radiation Damper

- UL rated for use in 1, 2, or 3 hour rated floor-ceiling, roof-ceiling design.
- Mounts directly to the fan, screws provided.
- Galvanized steel frame.
- High temperature, non-asbestos, reinforced fiber thermal fabric.
- 212oF fusible link.
- Stainless steel negator-type closure spring.
- Available for L100 through L700.

Metal Grille Kit

- White enamel painted steel.
- Mounting screws included.

OPTIONS & ACCESSORIES (CONTINUED)

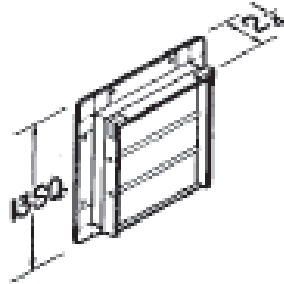

Model 441 Wall Cap

- Gravity dampers
- Collar with birdscreen for attaching 10" round duct
- Steel construction with aluminum louvers

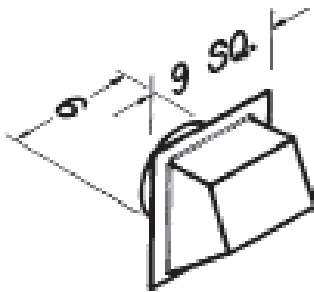

Model 641 Wall Cap

- Aluminum natural finish
- Built-in backdraft damper & birdscreen
- For 6" round duct

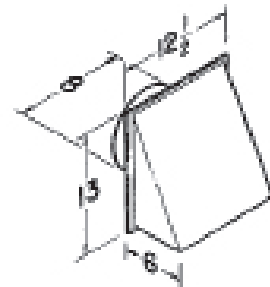

Model 643 Wall Cap

- Aluminum natural finish
- Built-in backdraft damper
- For 8" round duct

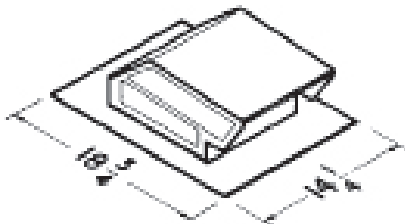

Model 634 Roof Cap

- Black electrically - bonded epoxy finish
- Built-in backdraft damper & birdscreen
- For 3 1/4" x 10" or up to 8" round duct

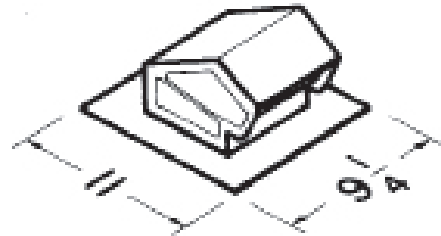

Model 636 Roof Cap

- Black electrically - bonded epoxy finish
- Built-in backdraft damper & birdscreen
- For 3" or 4" round duct

OPTIONS & ACCESSORIES (CONTINUED)

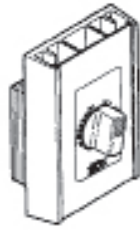

Speed Control

- Adjust speed from 100 to 50%
- 5 amp & 10 amp - 120V

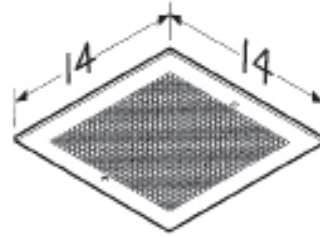

Model MG 1 Metal Grille Kit

- White enamel painted steel
- Mounting screws included
- Fits L100, L150, L200, L250 & L300

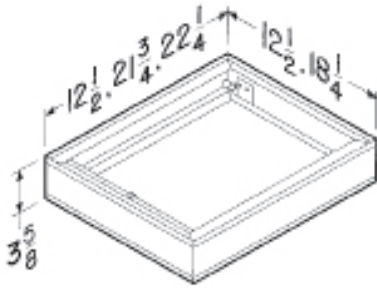

Models RD1 & RD2

- UL rated for use in 1, 2 or 3 hour rated floor-ceiling, roof-ceiling design
- Galvanized steel frame
- High temperature, non-asbestos, reinforced fiberthermal fabric
- 212 °F fusible link
- Stainless steel negator-type closure spring
- RD1 (12 1/2" X 12 1/2") fits L100 - L300
- RD2 (21 3/4" X 12 1/2") fits L400 - L700

OPTIONAL ACCESSORY COMPATIBILITY CHART

		LOSONE SELECT CEILING MOUNT				LOSONE SELECT IN-LINE/ CABINET		
		L100 L150	L200 L250 L300	L400 L500	L700	L100L L150L	L200L L250L L300L	L400L L500L L700L
VARIABLE SPEED CONTROLS	2727.1 (5 AMP 120V) ●	X	X	X		X		
	2828.1 (10AMP 120V) ●	X	X	X	X	X	X	X
Roof Caps	634 ●	X	X			X	X	
	636 ●							
WALL CAPS	441 ◆			X	X			X
	641 ●	X				X		
	643 ●		X				X	
UL RADIATION DAMPERS	RD1 ◆	X	X					
	RD2 ◆			X	X			
	RD3 ◆							
METAL GRILLE KIT	MG1 ●	X	X					
VIBRATION DAMPENING HANGERS (4)	V102 ●	X	X	X	X	X	X	X
	V104KIT ●	X	X	X	X	X	X	X

Losone Select Series

CEILING & INLINE/CABINET VENTILATORS



LOSONE SELECT CEILING MOUNT PERFORMANCE

Losone Select Ceiling Mount Ventilator														
MODEL	AMPS @ 60HZ / WATTS	RPM @ 1/8	Voltage	CFM / Sones at Static Pressure (PS - Inches of H ₂ O)										Average Ship Wt. Lbs
				0	1/10	1/8	1/4	3/8	1/2	5/8	3/4	7/8	1	
L100	1.1 / 87	640	120	136	115	109	93	80	65	44	-	-	-	23
				0.5	0.8	0.9	1.3	1.8	2.3	3	-	-	-	
L150	1.3 / 100	710	120	181	161	157	141	132	124	114	94	62	-	
				1.3	1.4	1.5	2.2	2.6	3.1	3.6	4.1	4.6	-	
L200	1.8 / 127	740	120	231	214	210	196	186	177	165	144	113	51	
				1.6	1.8	1.7	2.3	2.9	3.5	4.1	4.9	5.3	5.3	
L250	2.1 / 166	830	120	272	261	259	250	242	233	218	201	165	99	
				2.1	2.3	2.2	2.9	3.3	3.9	4.4	4.8	5.5	5.8	
L300	2.6 / 212	905	120	312	309	308	303	296	287	273	254	219	125	
				2.8	2.9	2.9	3.3	3.5	3.9	4.3	4.7	5.1	5.6	
L400	1.4 / 146	735	120	480	442	434	388	344	299	229	182	114	-	
				2	2.4	2.3	2.8	3.3	3.8	4.5	4.8	5.4	-	
L500	2.2 / 232	810	120	538	520	514	491	463	434	389	339	282	186	
				3	3.1	3.3	3.6	4	4.4	5	5.7	6.2	6.7	
L700	2.9 / 313	960	120	722	704	701	667	640	607	571	534	453	333	
				4.5	4.6	4.7	4.8	5	5.2	5.6	6.2	7.1	7.2	
L900	3.0 / 306	650	120	918	905	901	877	842	793	725	636	536	390	
				3.8	4	4.1	4	4.2	4.3	4.4	4.9	4.5	5.3	
L1500	5.0 / 468	955	120	1578	1526	1513	1438	1371	1285	1198	1103	1000	816	
				8.6	8.4	8.4	8.1	7.5	7	6.7	6.2	5.8	5.8	

Performance ratings include the effects of inlet grille and backdraft damper in the airstream. Speed (RPM) shown is nominal. Performance is based on actual speed of test. The sound ratings shown are loudness values in fan sones at 5' (1.5m) in a hemispherical free field calculated per AMCA Standard 301. Values shown are for installation Type B: free inlet fan sone levels. Performance certified is for installation Type B: Free inlet, Ducted outlet.



S&P USA Ventilation Systems, LLC., Div. of Soler & Palau Ventilation Group, certifies that the Losone Select Series shown herein are licensed to bear the AMCA Seal. The ratings shown are based on test and procedures performed in accordance with AMCA Publication 211 and AMCA Publication 311 and comply with the requirement of the AMCA Certified Ratings Program.



Losone Select Series

CEILING & INLINE/CABINET VENTILATORS



LOSONE SELECT INLINE/CABINET PERFORMANCE

Losone Select Inline/Cabinet Ventilator														
MODEL	AMPS @ 60HZ/ WATTS	RPM @ 1/8	Voltage	CFM / Sones at Static Pressure (PS - Inches of H ₂ O)										Average Ship Wt. Lbs.
				0	1/10	1/8	1/4	3/8	1/2	5/8	3/4	7/8	1	
L100L	1.0 / 87	760	120	121	108	106	97	93	86	70	44	-	-	23
				0.5	0.7	0.7	1.1	1.4	1.8	2.1	2.4	-	-	
L150L	1.3 / 100	920	120	153	148	147	140	134	125	111	91	54	-	23
				0.9	1	1.1	1.4	1.6	1.9	2.1	2.2	2.4	-	
L200L	1.8 / 127	865	120	205	196	195	190	185	175	158	135	96	47	23
				1.7	1.9	1.9	2.1	2.3	2.4	3	3.3	3.4	3.4	
L250L	2.1 / 166	1005	120	248	245	245	241	235	224	208	183	141	84	23
				2	2.3	2.3	2.8	2.8	3.2	3.4	3.6	3.9	3.8	
L300L	2.6 / 212	1145	120	300	294	293	285	274	259	243	214	168	113	23
				2.9	3	3.1	3.3	3.4	3.5	3.6	3.7	4	3.9	
L400L	1.4 / 146	775	120	450	415	406	360	313	271	223	167	90	60	34
				1.4	1.6	1.6	1.9	2.2	2.6	2.9	3.4	3.6	3.9	
L500L	2.2 / 232	890	120	546	526	519	496	472	447	407	364	306	232	34
				2.4	2.4	3.4	3.7	3.9	3.8	3.9	4	4.3	4.3	
L700L	2.9 / 313	1090	120	704	686	681	656	631	604	575	533	480	412	34
				3.6	3.8	3.7	3.9	4	4.2	4.3	4.4	4.7	5	
L900L	3.0 / 306	810	120	930	902	894	853	807	754	685	587	442	300	64
				3.7	3.8	3.8	3.8	3.7	3.8	3.9	4	4	4.1	
L1500L	5.9 / 468	1055	120	1275	1228	1214	1152	1092	1029	958	871	764	631	64
				6.8	6.8	6.7	6.5	6.3	6	6	6	6	6.1	

Performance ratings include the effects of backdraft damper in the airstream. Speed (RPM) shown is nominal. Performances based on actual speed of test. The sound ratings shown are loudness values in fan sones at 5" (1.5m) in a hemispherical free field calculated per AMCA Std. 301. Values shown are for installation Type D. Ducted inlet, Ducted outlet. Ratings do not include the effect of duct end correction. Performance ratings include the effects of 18 feet of round inlet duct and, if needed, a rectangular to round duct end correction.



S&P USA Ventilation Systems, LLC., Div. of Soler & Palau Ventilation Group, certifies that the Losone Select Series shown herein are licensed to bear the AMCA Seal. The ratings shown are based on test and procedures performed in accordance with AMCA Publication 211 and AMCA Publication 311 and comply with the requirement of the AMCA Certified Ratings Program.

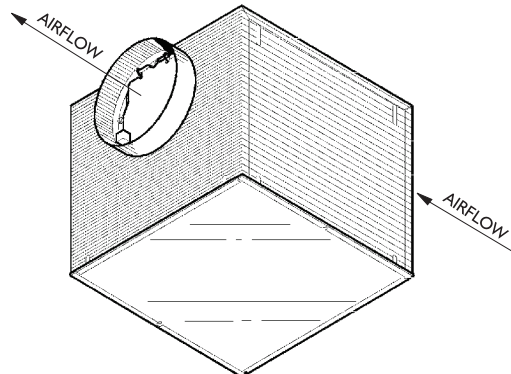

Losone Select Series

CEILING & INLINE/CABINET VENTILATORS



DIMENSIONS

LOSONE SELECT CEILING MOUNT VENTILATOR

L100 & L150

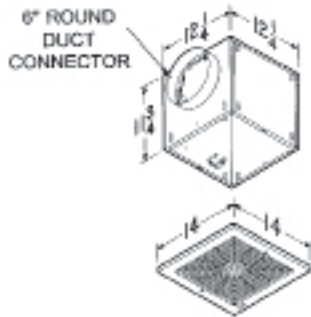

L200, L250 & L300

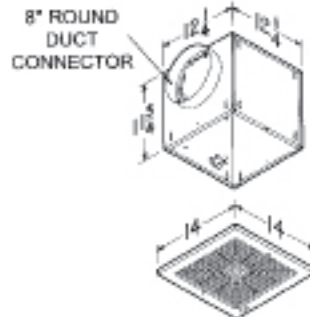

L400, L500 & L700

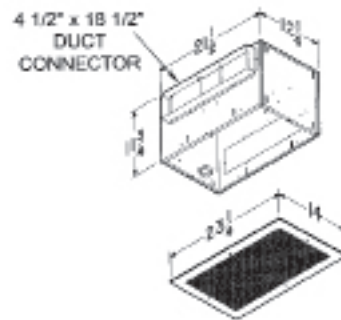

LOSONE SELECT INLINE/CABINET VENTILATOR

L100L & L150L

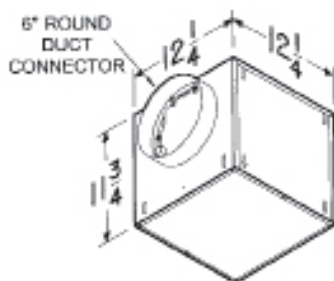

L200L, L250L & L300L

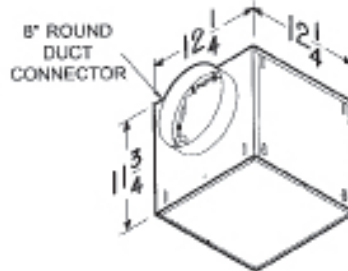

L400L, L500L & L700L

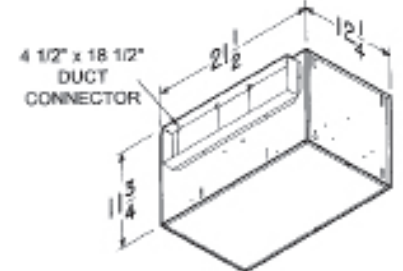

LOSONE SELECT CEILING VENTILATORS QUICK SELECTION GUIDE

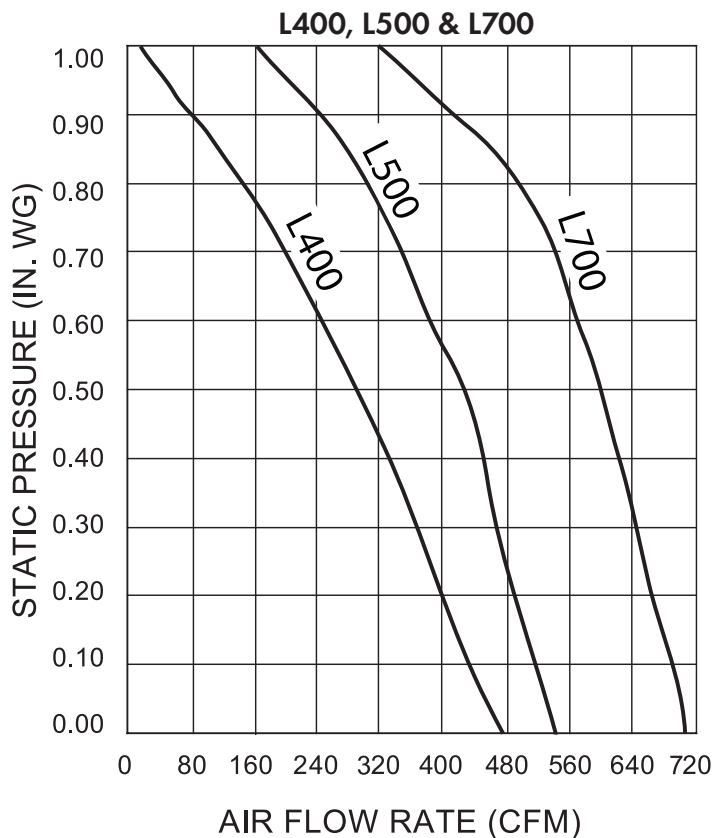
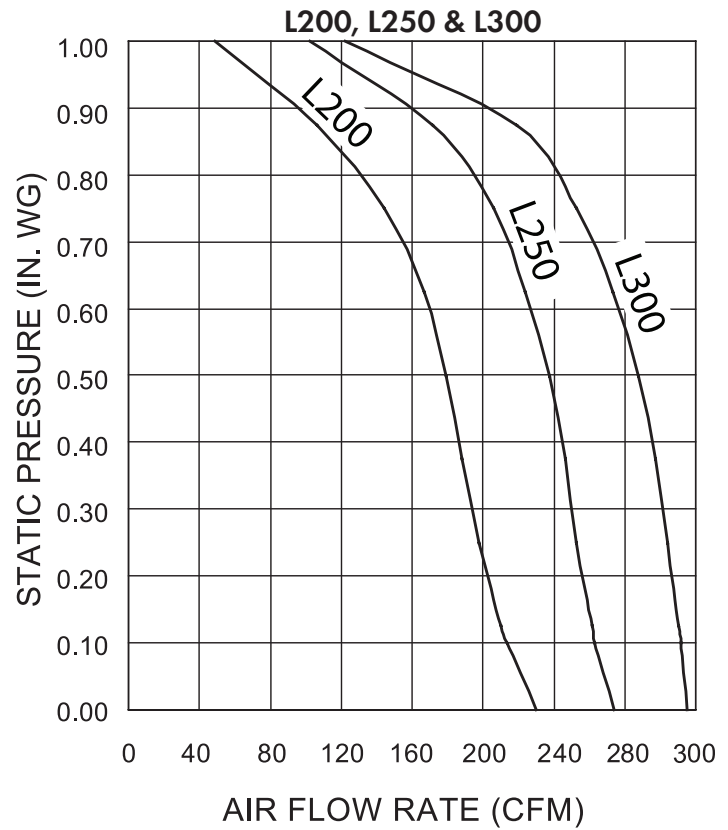
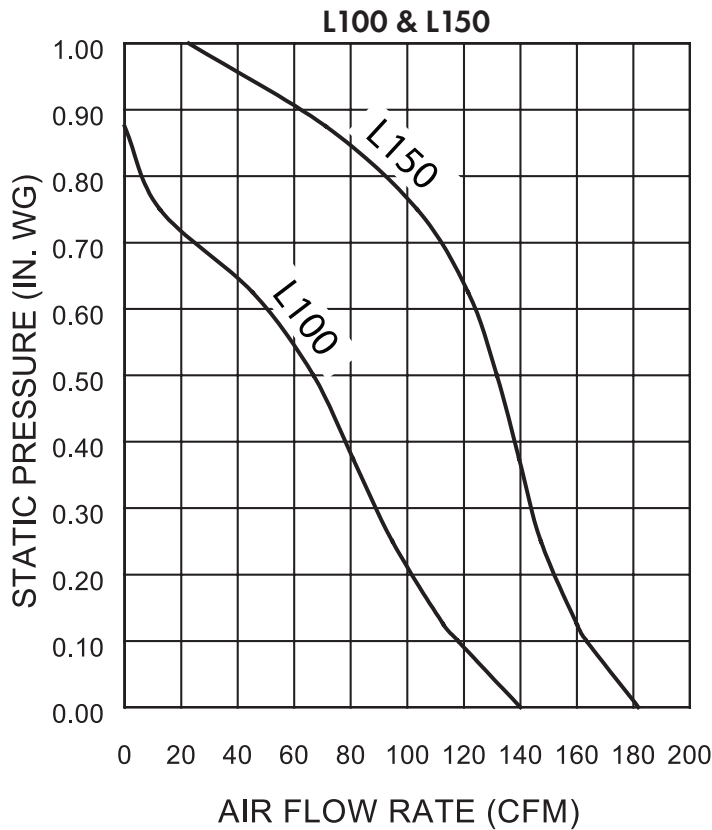

Models L100, L150, L200, L250, L300, L400, L500 and L700 Performance certified is for installation type B: Free inlet, Ducted outlet. Performance ratings include the effects of inlet grille and backdraft damper.

LOSONE SELECT INLINE/CABINET VENTILATORS QUICK SELECTION GUIDE

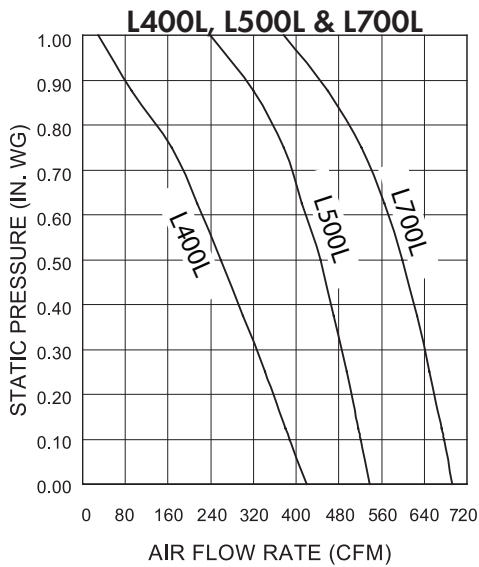
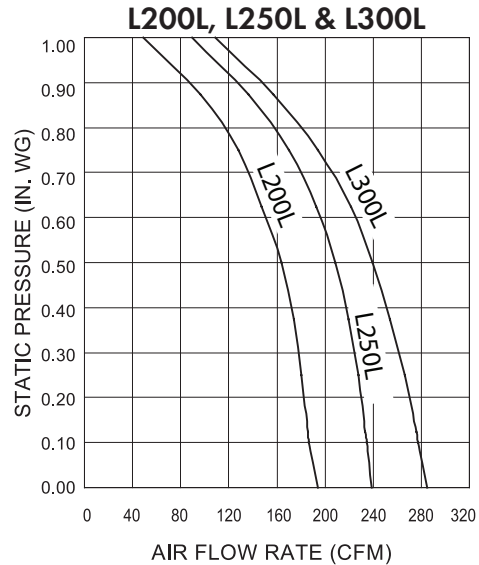
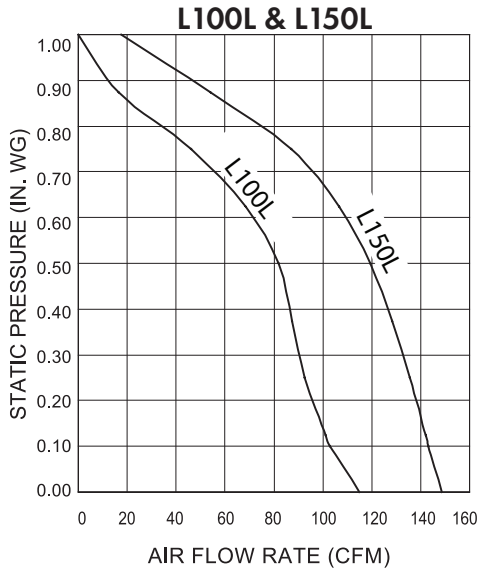

LOSONE SELECT SERIES QUICK SELECTION GUIDELINES

1. Locate desired CFM on bottom horizontal axis of graph.
2. Locate system static pressure on left vertical axis of graph.
3. Determine intersection of CFM and static pressure.
4. Select fan curve to the right of this intersection.
5. Solid state speed control may be used for selections left of curve, up to 50% CFM reduction.

Models L100L, L150L, L200L, L250L, L300L, L400L, L500L, L700L

Performance certified is for installation type D: Ducted inlet, Ducted outlet. Performance ratings include the effects of backdraft damper, 18 feet of round inlet duct and, if needed, a rectangular to round duct transition.



**ADVANCING
VENTILATION®**

S&P USA Ventilation Systems, LLC
6393 Powers Avenue
Jacksonville, FL 32217
T. 904-731-4711 • F. 904-737-8322
www.solerpalau-usa.com

S&P Canada Ventilation Products, Inc
6710 Maritz Drive Unit #7
Mississauga, ON L5W 0A1 - Canada
T. 416-744-1217 • F. 416-744-0887
www.solerpalaucanada.com

Soler&Palau 
Ventilation Group